



# Irrigation (Drip) and Fertilization Scheduling in Strawberry

G. Curzel (I.C.U.) - Irwa Project - Jordan

# Irrigation Water and Fertilizers Scheduling (BMP)

In case of

- **Full field cultivation**

*Calculation must be made on the base of surface planted (hectare)*

1. *available water restore*
2. *restitution of nutrients*
3. *crop coefficient **K<sub>c</sub>** and plant soil coverage*

- **Soilless cultivation**

*Calculation must be made on the base of linear meters of plants container*

1. *Constant water availability*
2. *Nutrients content according to the development stage of the crop and*
3. *according to the fluctuation of the micro-environmental conditions: light (day/night, sunny/cloudy) and temperature*



# Full Soil cultivation

**Irrigations schedule must be based on the soil water status.**

Three procedures may be used:

- 1) a water balance procedure based on the estimated crop water use rate and soil water storage
- 2) a direct measurement procedure based on instrumentation to measure the soil water status, and
- 3) a combination of the above two methods in which soil water status instrumentation is used with a water balance procedure.

These procedures require a knowledge of

- the crop water requirements
- effective root-zone
- soil water-holding capacity
- irrigation system capabilities in order to schedule irrigations effectively.

# Proper water scheduling means:

## Application of water to crops

1. only when needed and
2. only in the amounts needed

That is

- A. determining when to irrigate and
- B. how much water to apply

## Benefits of proper irrigation scheduling

- a. crop yields will not be limited by water stress from droughts
- b. water and energy used in pumping will be optimized
- c. loss of nutrients from leaching as a result of excess water applications will be minimized
- d. pollution of groundwater or surface waters from the leaching of nutrients will be reduced

# EVAPOTRANSPIRATION (ET)

The combination of evaporation and transpiration is called evapotranspiration (ET).

Because the amount of water assimilated by a plant is very small as compared to ET (about 1,0%), ET alone is often considered to be the crop water requirement -- the amount of water required by a growing crop to avoid water stress.

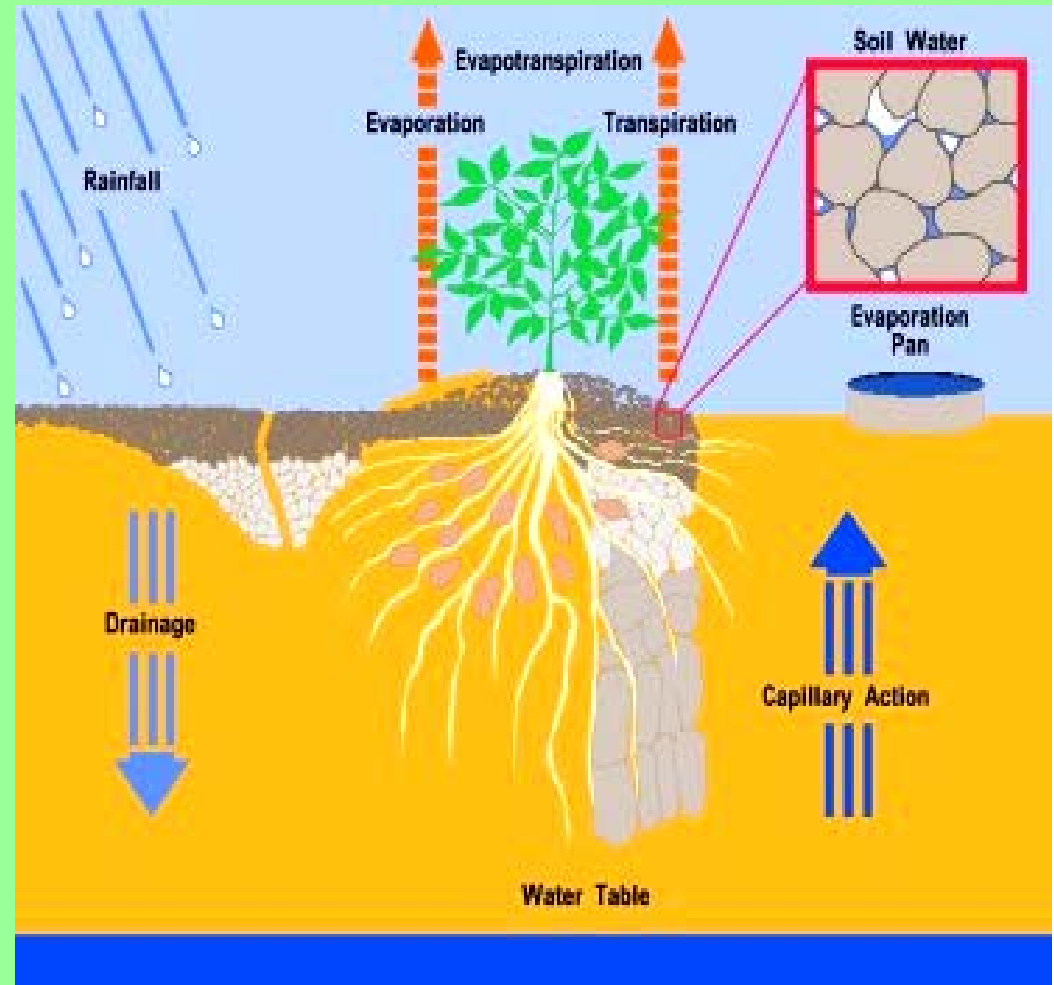

# FIELD WATER CAPACITY

- Crop root zone can be visualized as a reservoir where water is temporarily stored for use by the crop.
- The capacity of the soil-water reservoir (the volume of water stored in the crop root zone) and the daily rates of ET extraction from that reservoir must be known in order to determine the date of the next irrigation and the amount of water to be applied.
- Water balance of a field before and after irrigation

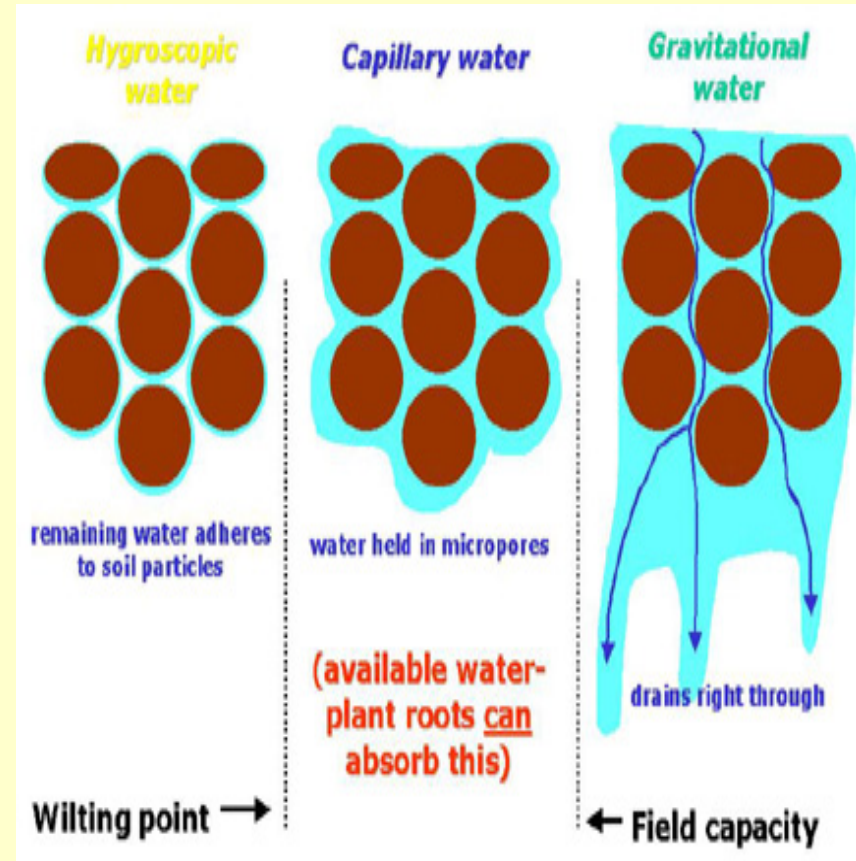



# Soil (available) water capacity

Available water capacity for various soil types (mm/10 cm)			
Type of soil	Range mm/10 cm of soil		Average
	Sands and fine sand	3	
Moderately coarse-textured sandy loams to fine sandy loams	8	13	10
Medium texture-very fine sandy loams to silty clay loam	10	15	12
Fine and very fine texture-silty clay to clay	12	21	16
Peats and mucks	16	25	21

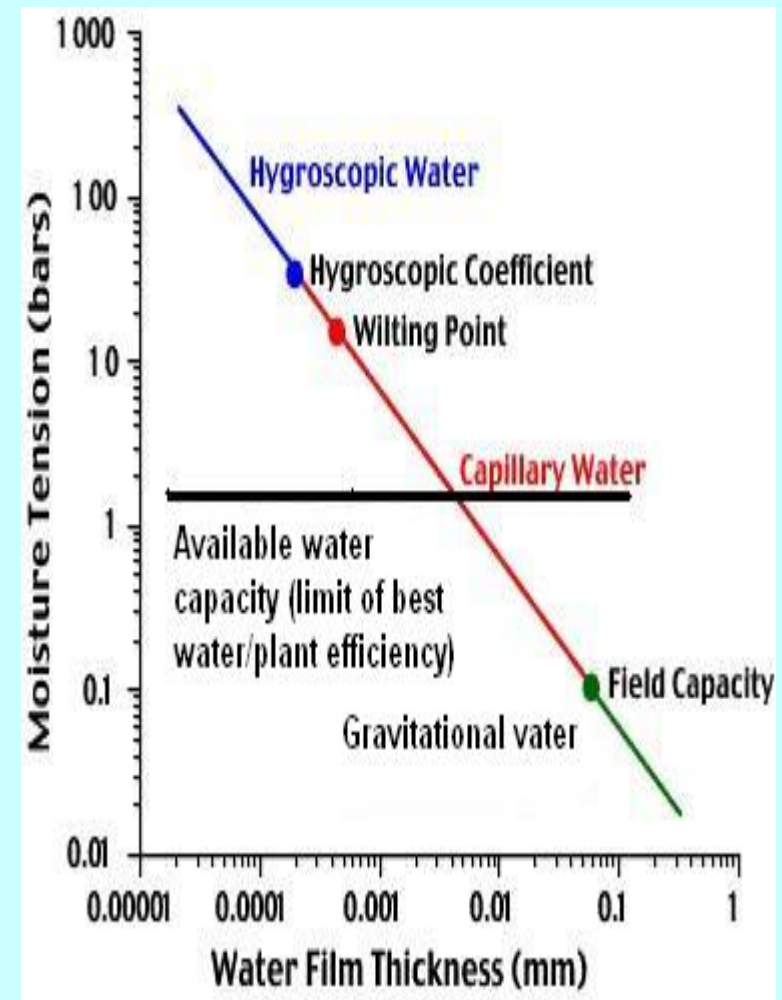

# Estimating Evapotranspiration

- Simple method of estimating daily ET in the field is by measuring evaporation from a free-water surface, since a correlation exists between crop ETo and evaporation from free water.
- The standard water surface commonly used is the Class A evaporation pan (Potential ET –ETp).
- Crop ETo is estimated by multiplying ETp by water use coefficients (Kc) for specific crops, growth stages (soil coverage by plant canopy), and management factors.
- Kc value for many strip-cultivated crops, including strawberry) as a rule of thumb, is assumed to be 1.0, while soil coverage is between 0,5 to 1,0.
- Soil depth explored by roots is between 10,0 and 20,0 cm
- For arid warm zones the daily ET can be assumed as high as 2,0 to 6,0 mm/day, (winter through summer respectively)



# Estimating water losses (ET)

Indirect measurement:

- Class A evaporation pan
- Atmometer
- Weather station

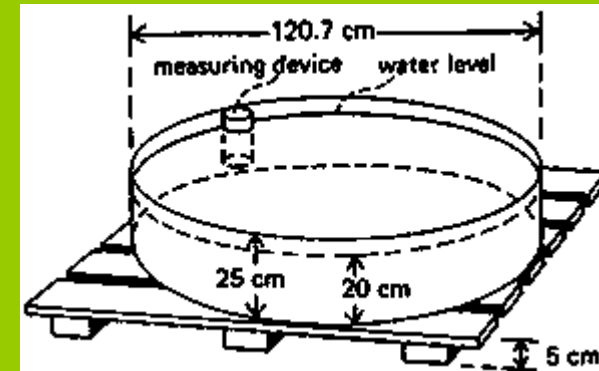

Direct measurement:

- Tensiometers
- Boioukos (gypsum blocks)
- Watermark device

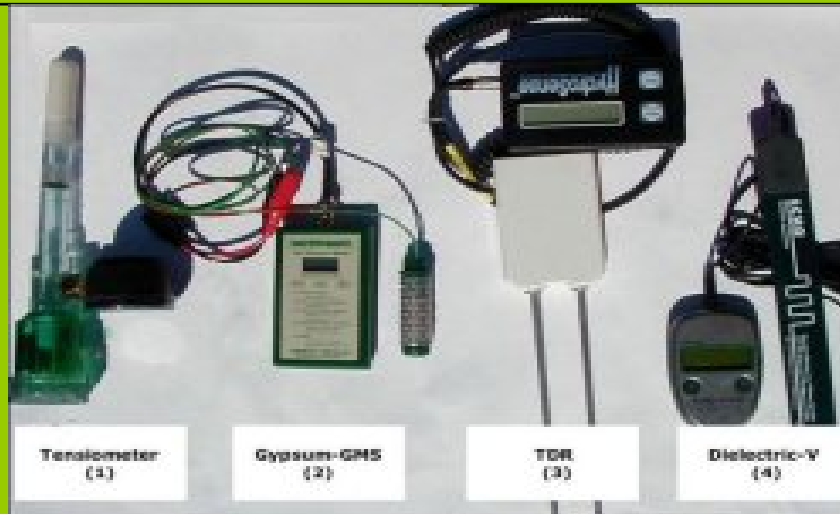

# Irrigation Amount Scheduling

***Irrigation amount should not exceed soil water holding capacity. Otherwise, water is wasted and mobile nutrients are leached.***

- It is possible to visualize soil water movements in a fixed time by adding colored dyes to the irrigation water
- Wetting patterns are affected by soil type, irrigation amount, and emitter spacing
- Determining Water Budget:

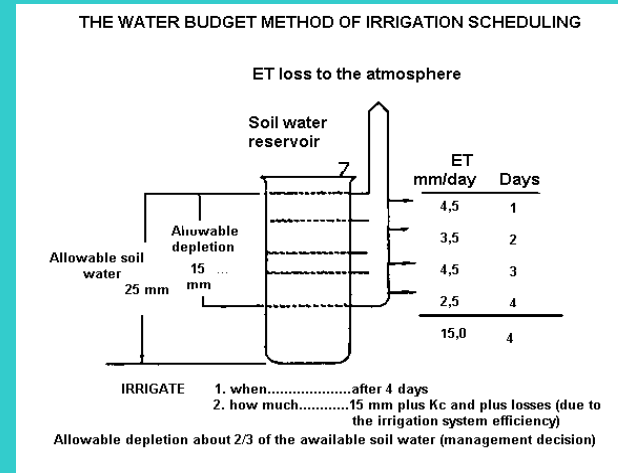

# Water budget example (sandy soil)

- Total available water depth in the root zone = 25 mm
- Management decision: irrigate at 2/3 of available water depleted
- When: after 4 days
- How much:
- $15\text{mm/ha} \times 1 \text{ (Kc)} \times 1,2 \text{ (losses)} =$   
**18mm/ha = 180 mc/ha**

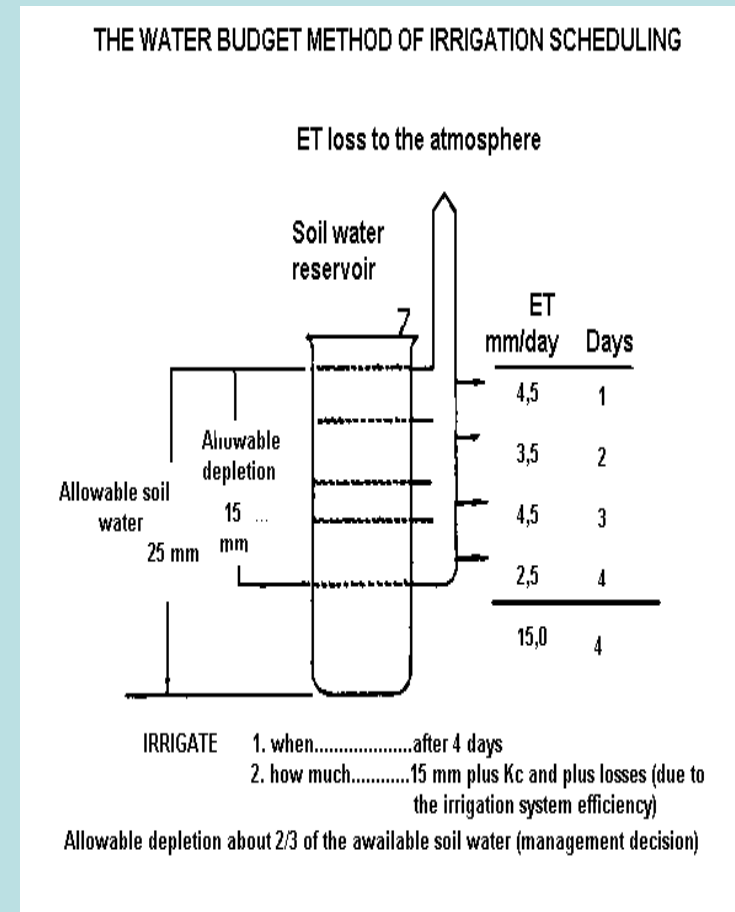

# Strawberry fertilization (fertigation)

- In full soil: traditionally 50% before planting and 50% through fertigation (based on soil and foliar analysis)
- In soilless culture: 100% through drip irrigation system (based on solution nutrient control and foliar analysis)

# Determining fertilizer (full field)

## Basic principles:

- Compensation of crop uptake
- Increase or decrease according
  - to the soil nutrient content
  - to the crop production
  - to the physical soil properties
  - to the environmental circumstances

# Strawberry nutrients total uptake

(Data in Kg - from container-cultivated plants and 59,45 tons of fruits – P. Lieten)

N	P <sub>2</sub> O <sub>5</sub>	K <sub>2</sub> O	MgO	CaO	Fe	Mn	Zn	Cu	B
125	40	190	23	78	5	1,4	0,15	0,055	0,32



**Nutrients Uptake Fluctuation** (in mmol/l of absorption for macronutrients and  $\mu\text{mol}$  for trace nutrients)  
 related to the main development stages:  
 1 – First growth, 2 – Flowering, 3 – Green fruit, 4 - Harvest

Stages	1	2	3	4
N	18	18	12	10
P <sub>2</sub> O <sub>5</sub>	1,85	1,4	1,4	1,1
K <sub>2</sub> O	4.2	7,3	5,7	4,8
CaO	4,8	5,1	4,2	3,7
MgO	1,2	1,7	1,1	0,8

Stages	1	2	3	4
Fe	20	24	13	11
Mn	35	40	34	27
Zn	Constant betw. 20 and 30			
Cu	0,08	0,1	0,28	0,25
B	23	40	33	39

# Soilless Cultivation (Protected)

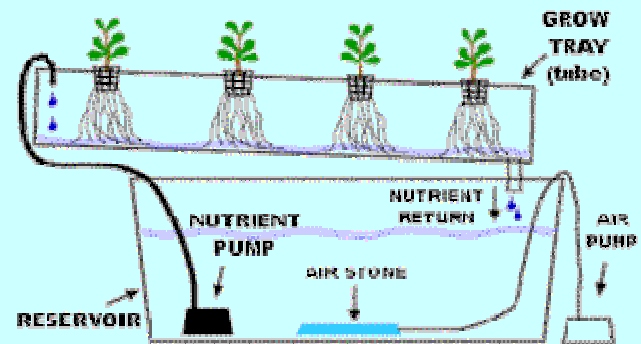
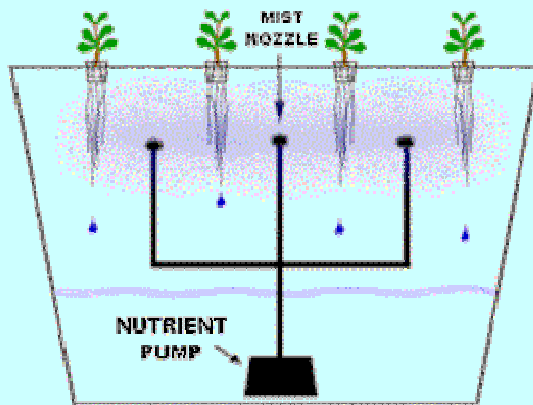
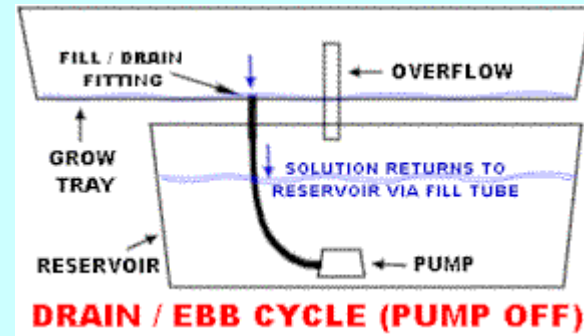
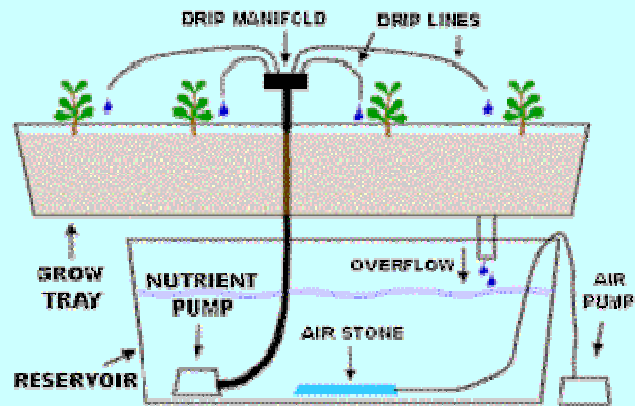

# Advantages and disadvantages of soilless cultivation

## Advantages:

- No needs to change soil (especially for small producers) over the years
- Not sensitive beside the soil variation in physical components, nutrients content, pests, diseases and temperature
- Off-season production
- Diseases and pests better control
- Fruits easier to be picked (more kg/hour)
- Cleaner fruits
- Higher income

## Disadvantages:

- High investment capital
- Sophisticated management
- Low salinity water required
- Pollutant discharge



## The (closed) system layout

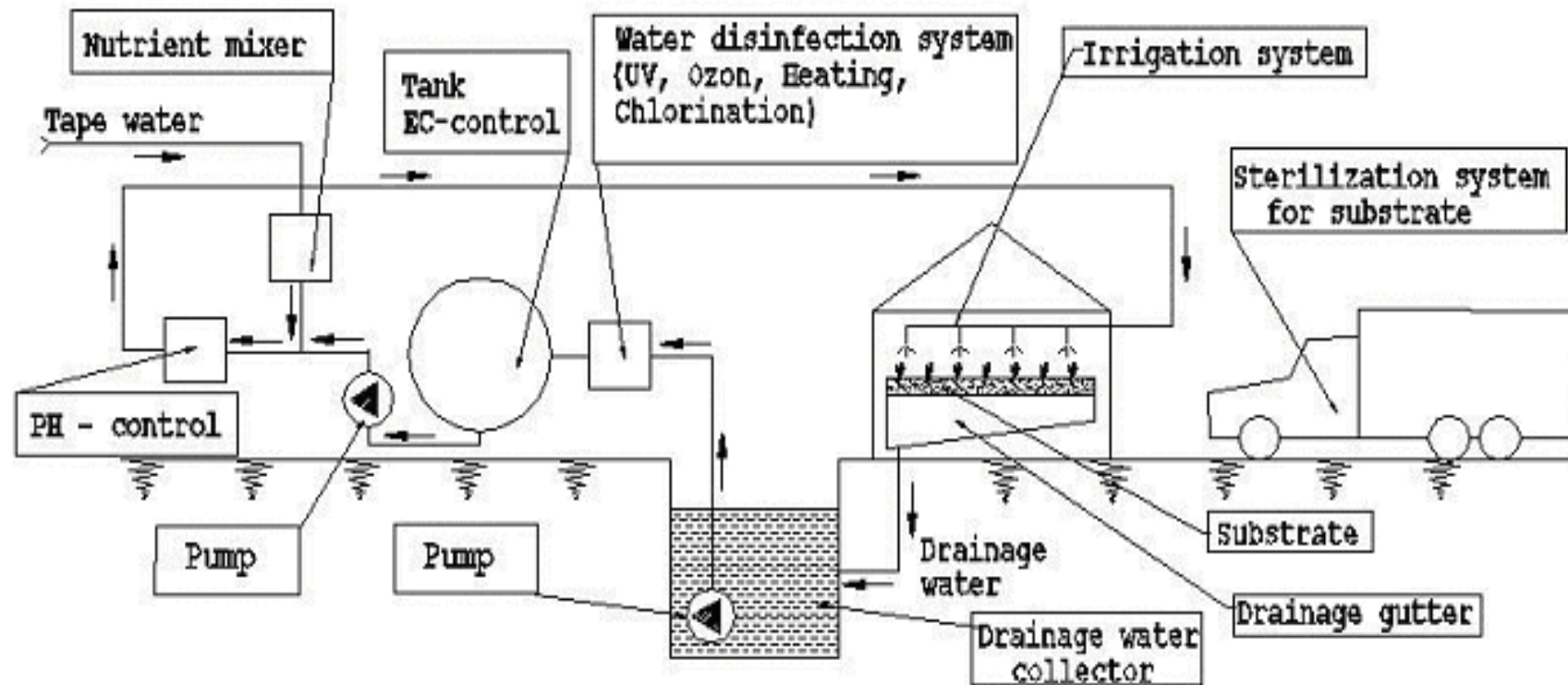
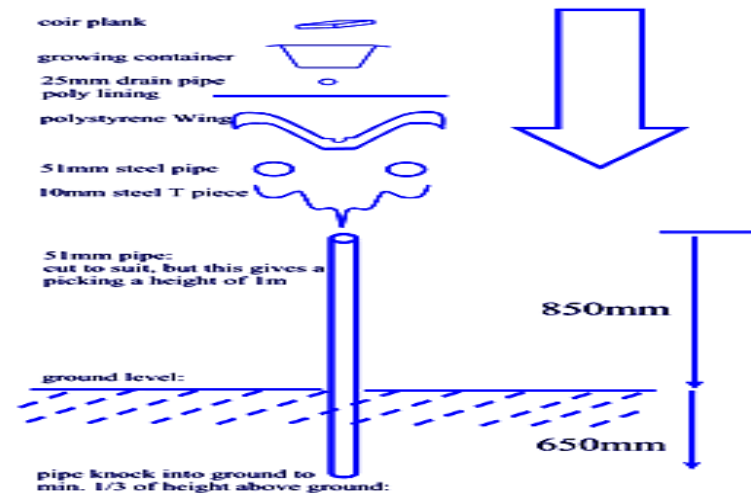
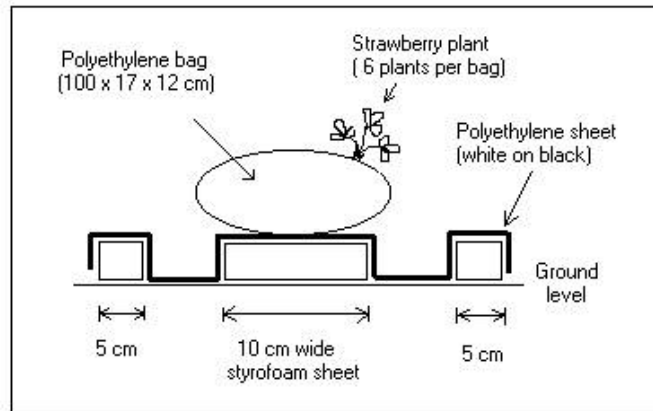

Fig.1 Current greenhouses recycling water and substrate treatment technology

# Options



## Water and Solution Components

- **Water quality:** Conductivity (tested at 25°C) less than 0,5 mS/cm and never higher than 0,8
  - **upper limits** for **Cl<sup>-</sup>** 52 mgr/l and for **Na<sup>+</sup>** 35 mgr/l. For **Sulphur** between 48/96 mgr/l. **Boron** limit 0,30 mgr/l. **Iron** 1,0 mgr/l. **Zinc** 0,35 mgr/l.
  - **pH:** between 5,0 and 6,0.
    - If lower then the macro nutrients adsorption is hampered
    - If higher then the same for trace elements (beside blocking P and Fe
    - If lower: mend by HNO<sub>3</sub> , if higher by KOH.
- **EC of the solution (using substrate): between 0,8-1,2 (summer) and 1,4-1,7 (winter)**
  - **lowest EC during harvest (about 1,2) and at transplant – about 3/4 weeks - (0,8)**
- **Fertilizers:** the total of cations and of anions are about equivalent, being monovalent ions like Cl<sup>-</sup>, Na<sup>+</sup>, K<sup>+</sup> and NH<sub>4</sub><sup>+</sup> more mobile than the bivalent ones, thus giving higher EC than Ca<sup>++</sup> and Mg<sup>++</sup>. Therefore different fertilizers used at the same quantity give different EC



# Nutrient Solution

Nutr.	NO <sub>3</sub>	NH <sub>4</sub>	H <sub>2</sub> PO <sub>4</sub>	SO <sub>4</sub>	K	Ca	Mg	Ca/(Ca+Mg)
mmol/l	7-10	0-0,5	1-1,5	1,0	3,5-5,5	3,5-4,5	1,0-1,5	
mgr/l	100-140	9,0	31-46	96,0	137-215	140-180	24-36	0,5/0,75
NH <sub>4</sub>	provokes excess of growth, while lowering the fruit quality, blocking Ca and Mg and decreasing flower induction. Therefore must be always under 9 mgr/l, being at last 10% of the total nitrogen and never at harvest. Note that decreases the substrate pH.							
K and Ca	Beginning flowering K-adsorption greatly increases, while Ca decreases and is most necessary before flowering for roots development.							
P and Mg	P is most important during roots development stage, while Mg is highly demanded during the vegetative development.							

# Nutrient Solution

## Optimum Average Amount of Trace Nutrients

Fe and Mn are mostly important at the stage of roots and leaf growth and development

B is required especially during the flowering

Nutr.	Fe	Mn	B	Zn	Cu	Mo
mmol/l	15-25	20-25	15-25	4,0	0,75	0,50
mgr/l	0,8-1,4	1,2-1,4	0,16-0,27	0,26	0,047	0,048

# Average foliar analysis data (% over DM)

## NOTICE:

- during the season the level of elements varies, therefore the following are bare references for orientation, for to prevent deficiencies.
- In fact: the trend of Ca, Fe, Mn and B is increasing along the season, while N, P, K, Cu and Zn is decreasing.
- Mg shows almost stable values.
- Between old and young leaves there are substantial differences: the young is richer in N,P and K, while the old one is higher in Ca, Fe, Mn and B.
- Therefore intermediate age leaves must be taken for analysis.

N %	2,0-3,5	Fe ppm	50-200
P %	0,3-0,6	Mn ppm	50-250
K %	1,5-3,0	B	30-90
Ca %	1,0-2,0	Cu	5-20
Mg %	0,3-0,5	Zn	20-65