



WASTEWATER IN AGRICULTURE



How can we ensure that public health is not compromised through wastewater use in agriculture? How can wastewater be best treated to protect both those who work in wastewater-irrigated fields and those who eat wastewater-irrigated foods, especially salad crops and vegetables eaten uncooked? Find the answer inside.



ECOLOGICAL SANITATION SYSTEMS

When it comes to anal-cleansing, the world can be divided into two major groups – the washers and the wipers. Manual washing requires about 1 - 2 litres of water per defecation. What ecological sanitation systems exist for communities that practice anal washing?



LE CENTRE DE FORMATION ET ...



... de Démonstration est une structure d'enseignement, de recherche, de démonstration et de formation continue rattachée au Département de Génie Rural de l'Institut Agronomique et Vétérinaire Hassan II à Rabat.

DECISION SUPPORT SYSTEMS



The Zer0-M project has developed a Decision Support System in order to contribute to the dissemination of the Sustainable Water Management approach.



This journal, "Sustainable Water Management", is an initiative of the project "Sustainable Concepts towards a Zero Outflow Municipality (Zer0-M). The project is part of the Euro-Mediterranean Regional Programme For Local Water Management (MEDA Water) of the European Union and the countries bordering the Mediterranean Sea.

In April this year the Regional Monitoring and Support Unit of the MEDA Water Programme organised a conference for all water partners of the region, national authorities of MEDA countries and project partners. This was a great opportunity for exchange and learning about water issues and efforts in Mediterranean countries.

As one of the most astonishing news of this exchange it emerged that the European Union was under the impression that water was a minor issue in MEDA countries. An ad hoc task group was formed to explore how this impression could have been created and to suggest actions in order to rectify it.

To hear, indeed, that water should be secondary or even unimportant in MEDA countries was quite unexpected for the attendees, to say the least. Very adverse effects on EU policies towards the region would have to be anticipated of such a position. Examining the possible causes of the impression conveyed by the EU the task group concluded that water in the countries of the European Union is part of the environment agenda and therefore is one element in the portfolio of respective Ministries for Environment. When EU environment ministers meet with their MEDA countries counterparts water is a minor topic because only those water issues directly related to the environment figure on the agenda of the environment ministers of the MEDA countries, whereas the key issues, e.g. water resources management, water supply and sanitation is located with the water ministries. The conference participants therefore issued the following recommendation in order to remedy to the false impression:

The participants would like to draw the attention to the fact that water in the MEDA countries is managed through Ministries and Institutions in charge of water. They highlight the necessity to coordinate water activities between the European Union and the MEDA countries through their respective national water structures.

The recommendations of the First Meda Water Partners Conference are printed in full on the next page for all readers to appreciate the issues raised and to assist in the final recommendation, "the delivery of these recommendations to the European Commission and to the European Parliament through their internal country structures". The conference participants hope the EU will give due attention to water in its coming initiatives towards the Mediterranean region, e.g. the Neighbourhood Programme.

Martin Regelsberger (m.regelsberger@aee.at)

List of Funding Organisations

- European Union, Meda Water Program of EuropeAid Co-operation office
- Austrian Federal Ministry for Foreign Affairs
- Agenzia regionale per la protezione ambientale della Toscana, Italy
- Acque S.p.A., Italy
- Tübitak-Marmara Research Center, Turkey
- National Research Center, Egypt
- Secrétariat d'Etat à la Recherche Scientifique et de la Technologie, Tunisia
- Population of El Attaouia, beneficiary of pilot plant, Morocco
- Technische Universität Berlin, Germany
- Zentrale Einrichtung für Weiterbildung, Germany
- fbr association and member companies, Germany



First MEDA Water Partners Conference
15 & 16 April 2007, Dead Sea, Jordan
Conference Recommendation 3

The Challenge of Rainwater Harvesting: Creating Awareness and Education
By Klaus W. König 4

Ecosan Systems that Accommodate Anal Washing
By Arno Rosemarin, Elisabeth Kvarnström, Marachi Subbaraman, V.Ganapathy, Linus Dagerskog and Kannan Pasupathiraj 9

Local Water Treatment and Reuse
A Study of Acceptance
By Friederike Arnold and Latifa Bousselmi 15

Reuse of Wastewater for Agriculture
By Duncan Mara 20

SWM Training and Demonstration Center at Tubitak Marmara Research Center (MRC)
By Ahmet Baban, Elif Atasoy, Selda Murat, Kemal Gunes and Selma Ayaz 23

Centre de Formation et de Démonstration de l'IAV Hassan II-Rabat
Training and Demonstration Center IAV Hassan II-Rabat
By Bouchaib El Hamouri and Martin Regelsberger 26

Do Local People Accept Our Grey-Water Technology?
By Peter Laban 31

Decision Support System for Sustainable Water Management
By Alexander Pucher, Sibylle Saul and Karel Kriz 35

Nor any Drop to drink
DVD Announcement 39

Events 39

Zer0-M Partners *Backcover*

IMPRINT

Eigentümer, Herausgeber und Verleger / Published by
AEE – Institut für Nachhaltige Technologien /
Institute for Sustainable Technologies

A-8200 Gleisdorf, Feldgasse 19, Tel.: +43 (0)3112 / 5886
Redaktion / Editors team: Elif Atasoy, Irene Bergmann, Barbara Regelsberger, Martin Regelsberger

"Sustainable Water Management" wird im Projekt Zer0-M vor allem für Wasserfachleute und Entscheidungsträger in den Projektländern herausgegeben. Bis zum Ende des Projekts erscheinen zwei Hefte pro Jahr.

"Sustainable Water Management" is issued within the Zer0-M project mainly for water experts and decision makers. Throughout the project it will come out twice a year.

Bankverbindung / Banking account:
Raiffeisenbank Gleisdorf, Kto.-Nr. 104.430, BLZ 38103, IBAN: AT09 3810 3000 0010 4430, SWIFT-BIC-CODE: RZSTAT2G103

WWW: <http://www.aee-intec.at>, <http://www.zero-m.org>

Typo, repro & design by STEINHUBER INFODESIGN, Graz

Druck und Versand / Printed and mailed by:

Universitätsdruckerei Klampfer, 8160 Weiz

Printed with soy based inks.

Auflage / Number of copies: 4.400

FIRST MEDA WATER PARTNERS CONFERENCE

15 & 16 APRIL 2007 / DEAD SEA, JORDAN



MEDA Water



The participants of aforementioned Conference have agreed on the following recommendations to activate the continuation of selected activities of the MEDA Water programme:

The Participants of the first MEDA Water Partners Conference agreed that water remains a high priority in general for the Mediterranean region and the MEDA countries in particular because of the pressure due to the increasing demand and scarce resources.

The MEDA Water Programme, funded by the EC, has been a success in many respects, especially regarding transfer and exchange of knowledge and experience between northern and southern countries from one side and among southern countries from the other side. It successfully introduced new approaches and strategies towards local water management. It brought together over 500 different stakeholders, from Governments, NGOs, and communities, often from remote and previously overlooked areas.

Multi-sectoral issues such as: climate change, sustainable energy, education, health, food security, water users' culture, capacity building, institutional reform, industry, urbanisation, tourism development, ecosystem preservation, and in some cases transboundary basin management... will have an impact on the water resources scene and will thus call for a new approach to the management of these resources.

The participants would like to draw the attention to the fact that water in the MEDA countries are managed through Ministries and Institutions in charge of water. They highlight the necessity to coordinate water activities between the European Union and the MEDA countries through their respective national water structures.

The participants agreed upon maintaining the network of the MEDA Water Programme partners, taking into account the existing structures such as EMWIS and MED-EUWI in order to bring together knowledge, innovation and experiences and to make the above available for new national and regional water projects or initiatives.

In order to keep the momentum gained from the MEDA Water Programme, the participants see the need to carry on with regional water activities (such as participatory management approaches, sustainable water management ...), under the existing or newly to be created EU support mechanisms, which should be specifically addressed to regional cooperation in the water sector.

The participants urge the delivery of these recommendations to the European Commission and to the European Parliament through their internal country structures.



CHALLENGE OF RAIN- WATER HARVESTING

CREATING AWARENESS AND EDUCATION

By **KLAUS W. KÖNIG***

Environmental protection can be defined as the basic provision for the continuing existence of mankind. Unfortunately the awareness of such an understanding is not automatically available even though everybody must contribute towards it.

* Dipl.-Ing. **Klaus W. König** is freelance architect, on the board of fbr, member of DIN committee NAW V 8 "Rainwater Harvesting Systems", Vice President of fbr (Association for Rainwater Harvesting and Water Utilization, Darmstadt/Germany), www.klauswkoenig.com



◀ Fig. 1:

SALEM COLLEGE: GROUNDWATER RECHARGE BY RAINWATER FROM PLANTED GREEN ROOF

I noted with interest the remark by the Hamburg Environmental Authorities that rainwater utilization plays a main part in this respect. In their opinion the utilization and processing of rain water will help bring about a growing awareness of environmental problems to other trade branches such as heating, road traffic, etc.

fbr ASSOCIATION FOR ADULTS

The fbr was founded in 1995. Its purpose is to promote water recycling and rainwater utilization, save drinking water and reduce sewage. Its responsibility lies in the creation of a provision against future contingencies, while at the same time taking into account all aspects of environmental protection, science and research.

It is a German nation-wide professional association of people, companies, local authorities, offices, specialized trading companies and institutions interested or already actively involved in water recycling and rainwater utilization. The association is a registered non-profit-making (NPO) organisation with its headquarters in Darmstadt, Germany. The fbr is a non governmental organisation (NGO). www.fbr.de

Within the association, members are active in work groups dealing with all the topics in the field of water recycling and rainwater utilization. Members are people, companies, local authorities, offices, specialist trade associations and institutions interested or already actively involved in the use of water recycling and rainwater utilization.

Since 2007 the fbr helps to organize the European branch of International Rainwater Catchments Systems Association (IRCSA). www.ircsa-europe.com

HOW TO INSPIRE CHILDREN

All of us must endeavour to educate the next generation to deal responsibly with energy and water. When I installed the rainwater harvesting system on my premises 16 years ago, I included a water level gauge which shows the height of the water level in the underground storage facility. This is of course completely unnecessary for the proper functioning of the system, as mains water make-up is automatically effected when so required.

When it rains and the children cannot go into the garden or play ball in the streets then they can go down to have a look at the level gauge and then after a few min-

◀ Fig. 2:

STEINER SCHOOL ÜBERLINGEN: TILE COVERED ROOF AS A COLLECTION AREA FOR RAINWATER



utes come proudly up to pronounce: “Well Dad, the rain has again provided more water for storage”. Simple devices like this can help children become aware of the environmental aspects of rain which they would otherwise regard as negative.

WATER THEATRE

In 1993 the pedagogical concept of the Water Theatre was born. The Ministry of the Environment of the German state of Hessen, in cooperation with the Natural Protection Centre at Wetzlar/Hessen, developed this idea for pre-school aged children. With puppets they showed the adventures of a raindrop. During the first seven years funds have been made available for 200 performances of this theatrical group under the direction of Mr. Lemb.

RAINWATER HARVESTING IN SCHOOLS

Salem College is the latest addition to the school at the Salem Palace, in the town of Überlingen on Lake Constance. Prince Max von Baden and Kurt Hahn, the great educator and reformist, founded this school, which is rich in tradition, in the 1920s. Since October 2000, nearly 100 students have been housed in this college, the largest private school in Germany. This insti-

Fig. 5:
STUDENT BUILDING IRRIGATION SYSTEM WITH RAINWATER AT STEINER SCHOOL



◀◀ Fig. 3:
**SALEM COLLEGE:
GROUNDWATER
RECHARGE BY
RAINWATER FROM
PARKING AREA
SURFACE**

◀ Fig. 4:
**WATER FESTIVAL
ÜBERLINGEN:
STUDENT PRE-
SENTING HIS
PROJECT**

tute is sponsored by the Deutsche Bundesstiftung Umwelt (German Federal Environmental Foundation) as an official project of the World EXPO 2000, Hanover. In a headline in the school’s promotional brochure, the administration proudly declares that: “Rainwater utilization is a prime example of how ecologically compatible processes can be employed without impacting water quality.” Water not being collected for utilization, (such as from parking area surfaces and from the dormitories’ planted roofs) is infiltrated into the ground as groundwater recharge.

STUDENTS MONITORING

The stated objective of the educators is to demonstrate the ecological aspects to their students in a clear and understandable manner. Instruments that monitor and control water and energy consumption demonstrate daily use; this provides an increased awareness of the technology applied and provides facts and Fig.s that back up theories.

STUDENTS PRESENTING AT A CONFERENCE

As part of the Überlingen Water Festival in October 2004, I was asked to organize a conference for students from schools of the Lake Constance region. The presentations were made by groups that worked on water projects in the school. One of those groups was the Burg Hohenfels School. Ten year olds taught fellow students

JAPANESE RAINWATER MUSEUM

As secretary general of PPRU (People Promoting Rainwater Utilization) and a chief of rainwater utilization promoting section of Sumida City Hall, Dr. MURASE organized the rainwater museum project. The first Rainwater Museum was created in a used elementary school in Sumida City by PPRU and opened on May 14, 2001. Sumida City commissioned PPRU to make the Rainwater Museum. Another theme of the museum is the expected water crisis in the 21st Century and ways in which rainwater utilization can mitigate this water crisis not only in Japan but all around the world.

SAFETY EQUIPMENT FOR DISASTERS IN TOKYO

Rojison literally means 'roadside respect' and indeed it is a symbol of neighbourhood safety and protection. Rainwater is collected in an underground tank from the roofs of nearby houses. This water can be pumped up with a hand pump and used in emergencies, to extinguish fires or in case of an earthquake. Local children use it in the summer to play and rojison water is also used to grow organic vegetables. Rojison are a familiar sight in the Mukojima area of Sumida, Tokyo.

Fig. 6:
**STEINER SCHOOL:
STUDENT BUILDING
IRRIGATION SYSTEM
WITH RAINWATER**



how to save potable water without reducing hygiene standards. Daniel Schmech, as the representative speaker for this group, was happy to announce that after half a year the school reduced water consumption by 30%. The money that had been saved by reducing water consumption was given to a water project of development in Guinea/Africa.

STUDENT BUILDING A RAINWATER HARVESTING SYSTEM FOR HIS SCHOOL

Another initiative in 2004 was the irrigation project at Steiner school in Überlingen. 18-year-old Manuel Oeder presented the ideas and results of his one year of studies. The task was to use the rainwater from the roof of the school for the irrigation of vegetables.

At German Steiner schools, the younger students learn how to grow vegetables as a lesson. The vegetables which are harvested are used in the kitchen of the school's restaurant. So irrigation by rainwater from the roof of the school helps to reduce storm water runoff problems in the city and at the same time it helps to feed the students. Manuel had to find professional help to plan and realize his project. It was his challenge to organize the project without help from his school. He asked me for advice and some companies for funding. The BOMMER plumbing workshop nearby supported him with tools and material. A manufacturer of rainwater harvesting systems, GEP, donated the pump and fittings. In the end he exhibited his project in Überlingen as part of the Water Festival. His teachers encouraged him to give a presentation to the public. Now the school saves potable water and has some contribution to the natural water cycle.

Fig. 7: ▶▶:
**MIYAKE ISLAND
ELEMENTARY
SCHOOL: SUPPLY
OF TAP WATER
(LEFT) AND RAIN-
WATER (RIGHT)**



Fig. 8: ▶▶▶
**MIYAKE ISLAND
ELEMENTARY
SCHOOL: RAIN-
WATER BASIN
WITH GOLDFISH**

CELESTIAL WATER ON PACIFIC ISLAND

Miyake is a Japanese Island of volcanic origin in the Pacific, located 200 km south of Tokyo. The technological age has also arrived here. The nearly 4000 inhabitants do not lack PCs or mobile phones: water, however, is a scarce commodity. Here, rainwater is not allowed to run off, since it ranks highly as so-called „celestial water". Sedimentation appears to be the prevalent purification process used. Traditionally goldfish, that swim in places that can be easily viewed in the cistern, are used to determine the toxicity of the water.





TEACHER OPENING RAINWATER DOWNPIPE

In the Bruckfelden School near Überlingen therapy workshops were extended for children and teenagers with handicaps. At the new building close to the classroom the down pipe was changed from a traditional closed round tube to an open U-shaped form. When the rain falls, students now can see and even touch the water running down towards the cistern. So they get a demonstration of the physical effect and thus believe that a fluid does not fall down like sand or other hard materials, but comes slipping along the down pipe profile, whatever shape it has. Knowing this effect, 20 years ago one of the most successful filter products for cleaning rainwater was developed by Norbert Winkler.

CHILDREN'S HOME WASHES WITH RAINWATER

The Breisgau metropolis Freiburg is known worldwide for its ecological commitment. For the „green“ mayor Dieter Salomon, the secret of the environmental head-start lies in the special „Freiburg mixes“: the communal-political decisions of the city, the commitment of the people in the region, the active support of the regional electric utilities and many organisations, institutions and companies. One of these institutions is the „Haus Tobias“, it lies at the edge of a forest above Herdern. It houses residential groups, a kindergarten, a school and a therapy workshop for children and teenagers with handicaps. The supporting organisation of the facility is the remedial Sozialwerk Freiburg e.V. Since 1968, the „Haus Tobias“ has been a fixed component of the social and pedagogic structure of the city of Freiburg in Breisgau. The extension of the home and school in 2003 helped meet the constantly increasing demand for space. The number of spots in the home could



then be stepped up from 15 to 45. A total of about 130 children are cared for here.

WATER, A “GIFT FROM THE SKY”

In “Haus Tobias”, the relief rainfall is “harvested”, which the clouds of meteorological depressions leave on the hillsides of the Black Forest. In this way, more than 1000 millimetres of precipitation are collected per year. That’s 1000 litres per square metre of free raw material, or a gift from the sky, depending on the way you look at it.

The philosophy of the social facility: The lasting interaction with nature is a prerequisite for the basis of existence of the following generation. Keeping additional costs in mind, the new building was equipped with a planted green roof and rainwater utilisation. Rainwater here isn’t only considered to be a raw material, but also an element of the natural cycle. Before it reaches the earth, this water undergoes a fascinating metamorphosis in the atmosphere and is too valuable to conduct it directly into the sewage system. Now there is only overflow from cisterns when these are full and it continues to rain. The overflow could be fed to the groundwater through the ground; but seepage is not possible here due to the hillside situation. A stream is planned in the centre of the facility with the recirculation of the rainwater, which runs off the reinforced area of the square and paths. It is not yet clear how this will be financed since it depends on donations.

ENVIRONMENT RELIEVED, OPERATING COSTS LOWERED

A system was realised for utilising rainwater in order to collect it from the surrounding roof surfaces at a justifiable cost. The responsible planning engineer, Bernhard Bruse, recalls: „By using rainwater, drinking water can be saved and also the rain drainage in the sewage system can be reduced. The operator benefits from this financially, it relieves the municipal sewage system

Fig. 9 + 10:
**BRUCKFELDEN
SCHOOL: U-SHAPED
OPEN DOWN PIPE**

Fig. 12: ►:
HAUS TOBIAS:
RAINWATER
COLLECTED FROM
THE ROOFS



Fig. 13: ►►
HAUS TOBIAS:
LAUNDRY WASHED
WITH RAINWATER



and contributes to protecting the environment". A washing machine's requirements are 200 l per week. The collection areas are 900 m² of extensively planted roof and 520 m² of roof surface with bitumen shingles. The storage tank size is 38 m³.

The caretaker Hans-Jörn Bosse is happy about the good performance of the system and explains: "The rainwater is cleaned in the central filter shaft, even before the cistern. Vertical sieves with a passage of less than 1 mm keep out the particles rinsed off the roof. Even floating substances, such as pollen, are kept out". The filter shaft and cistern lie underneath the central square.

Since commissioning the rainwater system in May 2003, more than 4 years have gone by. The managing director, Nikolaus Ebner, sums up positively: "We are satisfied in many respects. It was exciting to watch how far our rainwater supply can go. We were able to go through the dry summer of 2004 without having to use the drinking water feed. Even in the dry fall of 2005, the contents of the storage tank were enough to cover our high demand for the washing machines, plus the flushing water for the toilets and the irrigation of the outdoor installations. We are also happy that we haven't been able to tell a difference in the laundry washed with conventional drinking water from that washed alternately in rainwater."

CONCLUSION

Through applied projects such as this, students are proud to show the adult world what can be done for environmental protection as the basic provision for the continuing existence of mankind.

REFERENCES

- König, Klaus W. (1999 a): 'Rainwater in cities: A note on ecology and practice'. In: Inoguchi, Newman, Paoletto: Cities and the Environment. New Approaches for Eco-Societies, p. 203ff, United Nations University, Tokyo, Japan, ISBN 92-808-1023-5
- König, Klaus W. (1999 b): 'Rainwater Utilisation – Facilities and Equipment' In: Proceedings of the International Symposium on Efficient Water Use in Urban Areas, p. 93ff, UNEP International Environmental Technology Centre, Osaka/Shiga, Japan, ISBN 92-807-1815-0
- König, Klaus W. (2000 a): 'Rainwater Utilization for Economical Car Washing'. In: Journal of Ferrocement, p. 205ff, Pathumthani, Thailand, ISSN - 0125 1759
- König, Klaus W. (2000 b): 'Berlin's water harvest'. In: Water 21, p. 31ff, Magazine of the International Water Association, June 2000, London, UK, ISSN 1561-9508
- König, Klaus W. (2000 c): 'Berlin's Rainwater Harvest'. In: Water Resources Journal, No. 206, p. 63ff, Magazine of Economic and Social Commission for Asia and the Pacific, September 2000, Bangkok, Thailand, ISSN 0377-8053
- König, Klaus W. (2001): 'The Rainwater Technology Handbook' – Rainharvesting in Building. Fundamentals, practical aspects, outlook. Includes materials and tools for planning and design. 143 pages, color illustrations, hardcover, WILO-Brain, Dortmund, Germany, ISBN 3-00-008368-5
- König, Klaus W. (2003): 'Rainwater harvesting: public need or private pleasure?' In: Water 21, p. 56ff, Magazine of the International Water Association, Feb. 2003, London, UK, ISSN 1561-9508
- König, Klaus W. and Sperfeld, Dietmar (2007): 'Rainwater Harvesting, a global issue matures' In: Sustainable Water Management 1-2007, p. 31ff, part of Zer0-M project, funded by European Union. Gleisdorf, Austria, www.zer0-m.org

Fig. 11:
FBR: EUROPE'S
BIGGEST NGO / NPO
FOR RAINWATER
HARVESTING





ECOSAN SYSTEMS THAT ACCOMMODATE ANAL WASHING

By ARNO ROSEMARIN, ELISABETH KVARNSTRÖM, MARACHI SUBBARAMAN, V. GANAPATHY, LINUS DAGERSKOG and KANNAN PASUPATHIRAJ*

When it comes to anal-cleansing, the world can be divided into two major groups—the washers and the wipers. Washers strictly use water either manually or if available from a hand-held shower head, tap or bidet. Generally speaking, manual washing requires about 1–2 litres of water per defecation.

* Arno Rosemarin and Elisabeth Kvarnström, EcoSanRes/SEI, Sweden
 Marachi Subbaraman and V. Ganapathy, SCOPE, India
 Linus Dagerskog, CREPA, Burkina Faso
 Kannan Pasupathiraj, IFRC, Sri Lanka

The topic of anal-cleansing, however, is not well studied and little formal data is available regarding people's actual habits. But there are some regions of the world where anal-washing dominates such as South Asia, the Middle East, and various countries in Africa, Southeast Asia and Central Asia. The vectors of and effects of poor hygiene are better represented in the clinical literature relating to bacterial, viral and parasitic infections, diarrhea and other diseases. This short multi-authored communication deals with the question—what ecological sanitation systems exist for communities that practice anal washing? But it also deals with a series of implicit questions as follows:

ANAL-CLEANSING PRACTICES IN GENERAL

- What sorts of anal-cleansing habits do people have? Men, women, children?
- What are the implications regarding hygiene including hand hygiene?
- Do wipers also use water?
- What amounts of water do strict anal-washers use?
- What methods are used in anal-washing e.g. finger-contact cleaning and rinsing, splashing, spraying, etc.
- Are strict wipers less hygienic than washers, knowing that wiping leaves a dermal residual?
- Is more frequent bathing or showering a factor in the overall hygiene?
- How has PHAST covered anal-washing and what changes are necessary to build in ecosan options?
- What about school sanitation—is there a component in the training that deals with anal-cleansing?

DESIGN IMPLICATIONS

- How can dry and dry vault ecosan toilets be adapted to function to accommodate the use of significant amounts of water (1–2 liters per defecation) in anal-cleansing.
- What are the implications of strict anal-washing regarding toilet design for both squatting and pedestal toilets?
- What designs exist e.g. pour flush, flush, bidet, open pit, etc?
- And what about the collection and treatment implications?
- What is required to accommodate washing in the cases of dry toilets and UD dry toilets?
- This should include both soak away (urine and washwater), source separation with reuse (immediate in evapotranspiration bed and urine storage).
- What are the options for water-borne ecosan applications such as large-scale wetlands?

CASE HISTORIES

- How successful have the ecosan installations for washers been?
- What adaptations have been necessary on the part of the user (e. g. moving to wash station and having to inform new users)?
- What happens in the dry vault when too much water is added by uninformed users? (e. g. the central cone is flattened, cockroaches and flies increase, odour lingers)

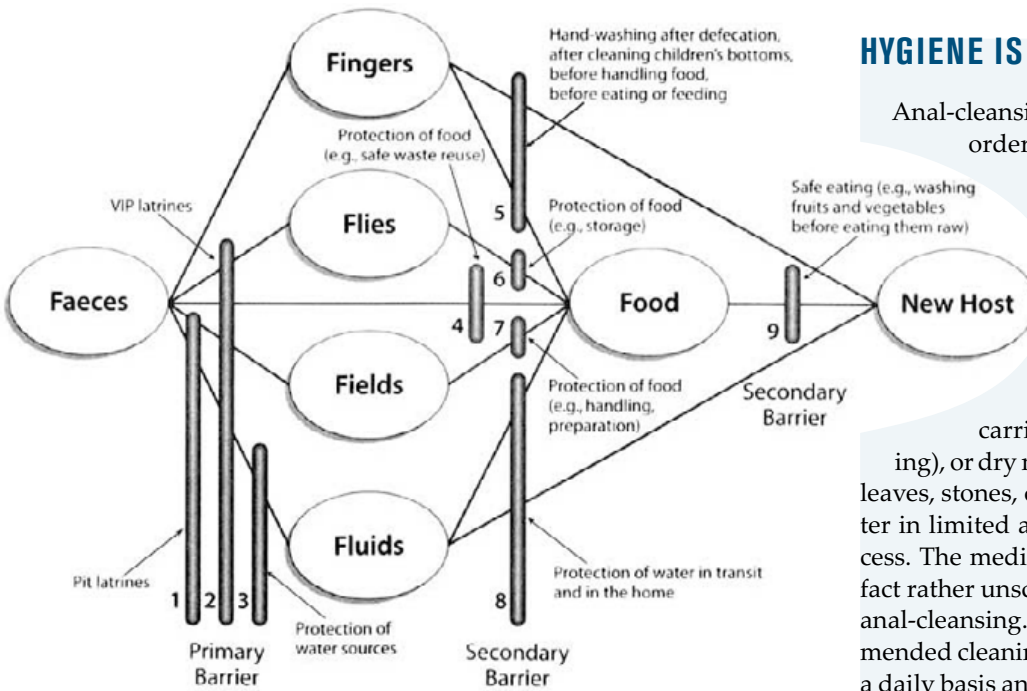

HYGIENE IS THE PRIMARY FOCUS

Anal-cleansing is necessary following defecation in order to remove faeces from the anal opening. The amount of faeces remaining for cleaning is dependent on the physical consistency of the stool which in turn is determined by the composition of the foodstuffs ingested but it can also be determined by the physics of the body position, squatting or sitting. Anal-cleansing is carried out using water alone (anal-washing), or dry materials used for wiping such as paper, leaves, stones, corn cobs, etc. Wipers may also use water in limited amounts to complete the cleaning process. The medical literature is rather informal and in fact rather unscientific when it comes to the subject of anal-cleansing. As late as only 24 years ago it recommended cleaning of the perianal skin be carried out on a daily basis and following each defecation in order to prevent "pruritus ani" or perianal dermatitis; and that pruritus is caused by inadequate anal cleansing or obsessive cleaning (Alexander-Williams, 1983). As late as the year 2000 this was questioned claiming that pruritus is probably not caused by traces of faecal material in tissue crevices (Rohde, 2000) and wet cleansing is a source of skin irritation. Either way, the fact remains that people carry out anal cleansing in various ways resulting in different hygienic conditions for both the individual and his or her surroundings. What is curious, however, is the paucity of rigorous scientific research into this question that in fact has major implications on public health and hygiene. That about 1.4 billion humans are infected with round worm (*Ascaris lumbricoides*) (WHO, 2004) is a major concern for hygiene specialists, thus making anal cleansing one of the more relevant issues.

As reported by Shojaei et al. (2006), poor personal hygiene by food handlers frequently contributes to outbreaks of food-borne illnesses caused by *Staphylococcus aureus* and gram negative bacilli such as *Salmonella*

Fig. 1: **FAECAL-ORAL ROUTES OF TRANSMISSION AND BARRIERS CREATED BY HYGIENE PRACTICE (ALMEDON ET AL. 1997)**

- What about public ecotoilets -is it possible to introduce such toilets?
- West African experience shows that washers are also interested in collecting and reusing source-separated urine and faeces. While the experience in South Asia tends towards wanting to soak away urine and anal-washwater either mixed or separately.
- What are the case histories from West Africa, the Middle East, South Asia, SE Asia and Central Asia?

This communication is based on the input from a few projects in West Africa and South Asia and should not be interpreted at this juncture as being a systematic survey.

SOME OBSERVATIONS ON ANAL-WASHING HABITS IN SOUTHERN INDIA (FROM SCOPE)

1. Anal-cleansing by hand is the general custom practiced in most countries where squatting pour-flush latrines are the most popular toilet model.
2. On an average two to three liters of water is used for each time in anal washing.
3. Women wash from the front and men from the back.
4. Children generally are washed by their relatives, most often by the mother or sister.
5. No one teaches the children how to wash. They learn by practice in the course of time.
6. There is a vital need for teaching children proper hand washing habits.
7. In most houses, toilets are not used for washing of hands.
8. Anal-washing is considered better and more hygienic than wiping.
9. Generally open or spot defecation is carried out close to where water is available, i.e. tank (barrage), river, etc.
10. Generally people take a bath following defecation in the nearby water source e.g. river or pond.
11. Open defecation is usually followed by bathing in the river or tank.

Fig. 2: **ECOPAN WITH ANAL WASHING AND URINE COLLECTION (PAUL CALVERT)**



spp., *Shigella* spp., *Campylobacter jejuni*; enterotoxigenic *E. coli* as well as viral agents such as hepatitis A, and Norovirus. Worm infections such as round worm (*Ascaris lumbricoides*), hook worm (*Ancllyostoma duodenal* and *Necatar americanus*), tape worms and pin worm are spread through poor hygiene practice. Prevention of bacterial, viral and parasitic infections originating from faecal contamination of mainly water and food can be carried out using various barriers as outlined in the so-called "F-diagram" (Fig. 1).

Hygiene promotion as described in the LSHTM handbook Hygiene Evaluation Procedures (Almedon et al., 1997) is an absolute necessity in order to reduce spreading of communicable diseases arising from poor personal hygiene. Hand-washing with hand-soap is particularly effective even when using contaminated water (Luby et al., 2001).

POUR-FLUSH PIT LATRINES DOMINATE

Pour-flush pit toilets are the most common sanitation solution in the rural areas of India and in many other countries in South Asia where anal washing is a mainstay. Western model toilets (pedestals) are preferred by economically progressive families normally in urban areas, hotels, public offices, airports, stadiums, etc. Septic tank models are mostly found in urban areas where there is no centralized underground drainage or sewage system.

The blackwater from these toilets is drained to a leach pit several meters deep and when the pit becomes filled with the collected sludge it is closed and a new pit is dug. Septic tanks (that don't leak) fill up and are emptied by pumping into a mobile tank wagon or vehicle. Since there is seldom capacity to treat the blackwater it is generally disposed of in an unhygienic manner in deserted areas, river beds, tank beds, roadsides, resulting in wholesale contamination. Pour flush toilets in general become dysfunctional in high water table areas or during the rainy season when the pits and the septic tanks fill with storm water. Pour flush and flush toilets however are the most popular in areas of the world that practice anal washing. What then is the experience thus far in accommodating anal washing in dry toilets—something that is almost a necessity in high water table or drought stricken areas.

ANAL WASHING USING URINE-DIVERTING DRY ECOSAN TOILETS

In order to help improved sanitation in the rural and village sector, dry toilets have been introduced during the last two decades in Southern India. Several popular toilet designs using urine diversion have been introduced. The first one promoted by Paul Calvert of Trivandrum, Kerala was a double-vault toilet with two drop holes for faeces built into the cement slab (see Fig. 2). The anal washwater and urine were collected in a central pot and then piped to a small evotranspiration bed containing plants. Special care has to be taken to ed-



Fig. 3:
THREE-IN-ONE
SQUATTING PAN
DEVELOPED BY
SCOPE IN TAMIL
NADU

ucate the user about anal washing in urine-diversion dry toilets. The user should be told that he/she should use only a minimum amount of water and ensure that the water does not enter the drop hole. A lid is placed over the drop hole before anal-washing. The more the quantity of water used increases the chances that water will enter the drop hole, getting mixed with faeces slowing the dehydration and sanitization processes. The breeding of cockroaches, flies, etc. are enhanced if the vault is not kept dry.

Newer models (eg Calvert's Ecopan www.eco-solutions.org/ecopan.html) are prefabricated plastic pans that are fitted into the slab, thus requiring less building time. These have been successfully introduced in both India and Sri Lanka.

SCOPE'S 3-IN-1 SQUATTING MODEL

In the household ecosan toilet model designed and promoted by SCOPE in Tamil Nadu, the urine, faeces and washwater are each collected separately. Urine is piped into a mud pot with holes which is diverted to the kitchen garden beside the toilet. Faeces are collected in the dry vaults below. Each vault is dry-composted over six to seven months and the contents used for soil conditioning. Washwater is collected in a separate bowl to the back of the pan and led into a filter bed which feeds into the adjacent garden.

In all cases there is a need for special-usage tutoring. The user has to apply ash after defecation to promote dehydration and sanitisation of the faeces, close the lid over the drop hole and then wash the anus with a limited quantity of water. The common mindset that anal-washing requires a 10-liter bucket of water has to be changed. The ecosan toilet is rather new and many people are still used to "flush and forget" toilets using three to four litres of water for anal-washing and about six to eight liters of water to flush the faeces to the septic tank or underground drainage sewer. The ecotoilets do not require such excessive volumes of water for anal washing. The habit of using a bucket of water each time greatly increases the chances of water entering the drophole in an ecosan toilet. The user needs to be properly informed that much less water is required and that

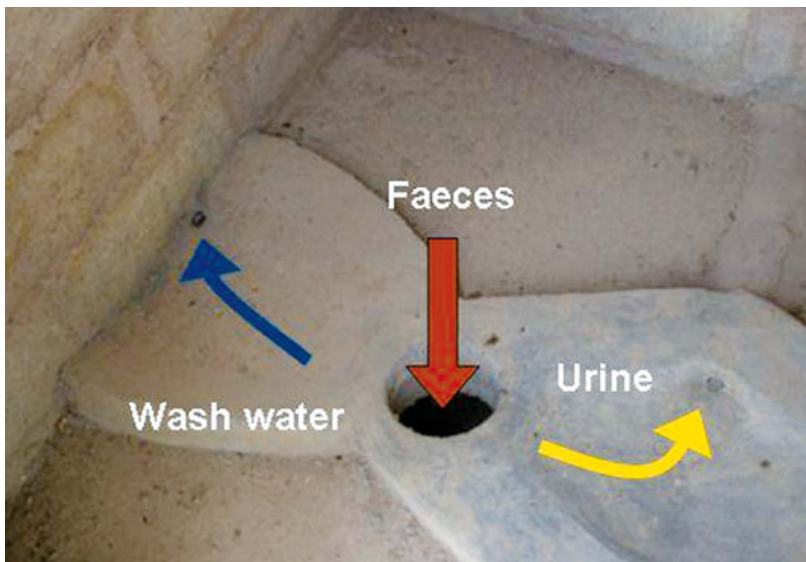

Fig. 4:
DESIGN FOR DISCHARGE OF ANAL WASH WATER FROM URINE DIVERTING DRY VAULT TOILETS IN BURKINA FASO

ash is to be applied to the faeces following each defecation.

When family relatives visit a house with an eco-toilet, they have to be instructed about the application of ash, covering the drop hole with the lid and washing with a minimum of water. At the same time they need to be told that they should wash their hands properly after use outside the latrine.

URINE-DIVERTING DRY ECOTOILETS FOR PUBLIC USE

SCOPE has also successfully constructed two community compost urine diversion toilets in Musiri near Tiruchi in Tamil Nadu. Both the toilets have gently sloped pipes for urine so as to ensure the free flow of urine. The user is told that while applying ash he/she should see that it is not falling inside the urine bowl. This will ensure that the ash will not clog the urine hole or urine pipe. About 200 liters of urine is collected in these public toilets per week and with arrangements with local farmers, the urine is used for watering plants like banana after dilution at a 1:10 ratio. The Tamil Nadu Agricultural University at Coimbatore is entrusted with the task of researching the storage properties and application of urine as liquid fertilizer to different plants. Additional training is required when it comes to fixing of the pipes connecting the urine hole to the urine pot and wash water hole to the filter bed, underneath the squatting slab. These community compost toilets have been functioning well for the past one year after some initial problems caused by users unaware of the required practices.

SCOPE has also installed one individual household ecosan toilet in the first floor of a house in Musiri and this too is functioning well.

ECOTOILET MANUFACTURING

Concrete slabs designed by SCOPE are now produced by over 100 trained masons in different locations in Tamil Nadu. A red oxide finish is applied to give a



Fig. 5:
DESIGN FOR A SEATER URINE DIVERTING DRY VAULT TOILET. ONE SEAT FOR URINE AND FAECES (RIGHT SIDE) AND ONE FOR ANAL WASHING (BURKINA FASO)

better aesthetic look as well. Fiberglass pans are also made commercially and supplied to individuals and community toilets. Ceramic urine diversion toilets have also been developed but their commercial production is yet to commence, awaiting for a minimum order of 500 units.

SCOPE has constructed one ecosan urine diversion toilet in a grade school where urine will be collected and used for irrigating cashew trees. The unit has only two toilets but 20 urinals since in educational institutions during class hours most students use only the urinals and only very few the toilets. The students will be given training in the usage of the urinals and toilets.

Thus far SCOPE has constructed over 900 ecotoilets of which 500 are in and near Musiri and 400 in Tsunami-affected coastal sandy belt areas on the east coast of Tamil Nadu, India.

CASE STUDY AND EXPERIENCE FROM CREPA COUNTRIES IN WEST AND CENTRAL AFRICA

CREPA is an interstate African institution working with ecological sanitation in 10 west and central African countries. At several of the project sites, the toilets must be adapted to anal washing. There are several examples in the CREPA network of how the anal wash water can be discharge separately from the toilet cabin, and how it can be taken care of. The water is discharged from the cabin separately and is then either infiltrated into the ground or reused in an evapotranspiration bed or a mulch bed so that plants or trees can benefit from the water and nutrients.

EXPERIENCE FROM SRI LANKA IN POST-TSUNAMI INSTALLATIONS

Several hundred urine diverting dry toilets (UDDT) have been installed in Sri Lanka following the Tsunami in reconstruction projects by Action Contre La Faim, Australian Red Cross, American Red Cross, Practical Action, International Federation of the Red Cross



Fig. 6 + Fig. 7:
ANAL
WASHWATER
DRAINED TO
A SOAKAWAY
(LEFT)
AND EVAPO-
TRANSPIRATION
BED (RIGHT) IN
MALI

(IFRC) and other organizations. One such initiative was the model village in the northern district of Jaffna where 16 families shared 5 toilets and use ash, soil and sand as additives to faecal collection chamber. Urine is diverted together with the anal wash water to a dispersion plant bed where plants like banana, papaya, tomatoes and coconut are planted. In some project locations the users have by themselves planted plants with larger foliage or with a high leaf area that are more suitable to the plant bed, to enhance evapotranspiration (e.g. leafy vegetables, banana, and cannas or *Cannaceae*).

Each vault is used for six months and then left to dehydrate and sanitize for six months. The users find this process of changing from one chamber to the other every six months easy as it is registered in their calendar instead of waiting until the chamber is full. The emptied material is neither compost nor a dehydrated mass but something in between. The excavated material is used for the plants by adding to the soil in the plant bed itself.

USER INSTRUCTION

To assist the users in using the toilets, technical officers and hygiene promoters (mainly women) visited the communities almost every day during the first week of usage. Discussions were initiated to understand the usage pattern and suggestions to change behaviour to suit the usage of UDDT were discussed. One family was advised to deliberately misuse the toilet and discuss the consequences with the community. It was noticed that this particular toilet had flies breeding in the faecal chamber. Then the community was asked to find a methodology to solve this problem, with the locally available knowledge. The community added an increased volume of dry sand to the vault, plus neem (*Azadirachta indica*) leaves which act as insect repellent. They dried the leaves and burnt them inside the vault. By doing this the community understood the importance of keeping the chamber dry and also learnt the mechanism of controlling insects. Moreover, some of them began adding fresh neem leaves to the vault when there was a suspicion of flies, mosquitoes or cockroaches.

ADAPTING ANAL WASHING IN DRY TOILETS IN JAFFNA

There were instances when the community in Jaffna discussed the splashing of rinse water into the dry vault during anal washing. The community itself came with a suggestion for double vault toilets where one vault is always sealed. They suggested facing towards the open drop hole as the splashed water would then be aimed in the opposite direction towards the closed hole. The communities also suggested closing the lid after defecation, before anal cleaning as a method to avoid wash water entry into the vault.

Anal cleansing is the only habit of personal hygiene in Sri Lanka, although people have adopted wiping after washing. The practice of anal cleansing is transferred from parents to children. It was also observed that the users used the left hand for anal cleaning, which they do not use for any action that would be intended for hand-mouth contact. Surprisingly there had been no instances of diarrhea in this community during the monitoring period of the first six months from the day of commencement of usage of UDDT. It was also noted that the anal cleaning water used is less than 2 liters per defecation. Individuals carried water into the toilets in small containers less than 2 liters in size. A pot for ash, soil or sand was placed in every toilet. Recent development is the usage of a hand shower for anal washing. Informal interviews with people using such showers shows that hands are not used in this practice.

CONCLUSIONS

Anal washing is not restricted to specific religions or countries of the world. Little data is available in fact as to what people's habits really are but there is knowledge about the general trends. Much progress has been made over recent years in the improved design and demonstration of ecotoilets adapted to anal-washing in mainly rural and peri-urban areas where onsite treatment can be carried out. Examples of such projects are in West African countries, Palestine, India, Nepal, Bangladesh, Sri Lanka and the Philippines. Major progress has also been made in the use of large-scale wetlands to

treat black and greywater from communities in Syria and Jordan. This communication reported on experience from West Africa and South Asia. Changes in the habits of the users is central to the success of the use of the dry ecotoilets. Less water is used for anal-washing in dry toilets than in flush or pour-flush systems, and the dry vault must be kept dry. This is done easiest by placing a lid over the drop hole prior to washing. Anal wash water is discharged into evapotranspiration beds with plants, adjacent gardens, mulch beds or into leach pits. In some cases urine and washwater are discharged together. These dry toilets are of particular relevance in areas where water tables are high and where there is a shortage of water.

CONTACT ADDRESSES

ECOSANRES PROGRAMME/STOCKHOLM ENVIRONMENT INSTITUTE

Arno Rosemarin, Research and Communications Manager, arno.rosemarin@sei.se,

Elisabeth Kvarnström, Node Development Manager, elisabeth.kvarnstrom@sei.se

Kräftriket 2B, 106 91 Stockholm, Sweden
Web: www.ecosanres.org

SOCIETY FOR COMMUNITY ORGANISATION AND PEOPLES EDUCATION (SCOPE)

Marachi Subbaraman, Director,
V. Ganapathy, Liaison Officer,

P/17, 6th Cross Ahamed Colony
Ramalinganagar, Tiruchirappalli – 620 003
Tamil Nadu, India.

Email: scopeagency86@gmail.com,
scopeagency86@rediffmail.com
Web: www.scopetrichy.org/

CENTRE RÉGIONAL POUR L'EAU POTABLE ET L'ASSAINISSEMENT À FAIBLE COÛT (CREPA)

Linus Dagerskog,

03 BP 7112 Ouagadougou, Burkina Faso
Email: linusdagerskog@yahoo.fr
Web: www.reseaucrepa.org/

INTERNATIONAL FEDERATION OF RED CROSS AND RED CRESCENT SOCIETIES (IFRC)

Kannan Pasupathiraj, CRRP-Watsan Coordinator

16/2 Gregory's Road, Colombo-7, Sri Lanka
Email: kpasupathiraj@redcross.org.au,
paskan@yahoo.com
Web: www.ifrc.org/

REFERENCES

- Alexander-Williams J. 1983. Pruritus ani. *BMJ* 287: 159-60.
- Almedom, A. et al. 1997. Hygiene Evaluation Procedures: Approaches and Methods for Assessing Water – and Sanitation – related Hygiene Practices. London School of Hygiene and Tropical Medicine.
- WHO. 2004. Global Epidemiology of Infectious Diseases. Christopher J. L. Murray, Alan D. Lopez, Colin D. Mathers (eds.). Geneva. 391 p.
- Luby, S.P. et al. 2001. Microbiologic effectiveness of hand washing with soap in an urban squatter settlement, Karachi, Pakistan. *Epidemiology and Infection* 127: 237-244.
- Rodhe, H. 2000. Routine anal cleansing, so-called hemorrhoids, and perianal dermatitis: Cause and effect? *Diseases of the Colon & Rectum* 43(4): 561-562.
- Shojaei, H. et al. 2006. Efficacy of simple hand-washing in reduction of microbial hand contamination of Iranian food handlers. *Food Research International* 39(5): 525-529.

OTHER LINKS OF INTEREST

- www.schoolsanitation.org/BasicPrinciples/Anal_Cleansing.html
- http://en.wikipedia.org/wiki/Anal_cleansing
- http://practicalaction.org/practicalanswers/product_info.php?products_id=131
- www.gtz.de/de/dokumente/en-ecosan-tds-02-b1-dehydration-toilets-double-vault-ud-2005.pdf
- www.lboro.ac.uk/well/resources/well-studies/full-reports-pdf/task0324.pdf
- www.permanente.net/homepage/handbook/healthwisehandbook/ch_04/ch_04#rectal_problems.htm
- www.eob.alvsbyn.net/principlesEOB.htm



LOCAL WATER TREATMENT AND REUSE

A STUDY OF ACCEPTANCE

By FRIEDERIKE ARNOLD and LATIFA BOUSSELMI*

In Tunisia, the management of water is a thousand-year-old exercise which leads to practices respectful of this element and related to its collection as well as the rational use and maximum valorisation. Thus rainwater was often collected. Appreciated for its quality, it is preciously protected and used for human use [1].

* **Friederike Arnold**, environmental psychologist, writes her thesis on Technology Mediation at the Institute of Geography, Humboldt University, Berlin, Germany, friederike.arnold@geo.hu-berlin.de
Dr. **Latifa Bousselmi** is a researcher at the Water and Environment Laboratory of Scientific and technical research institute (INRST) in Tunisia, Latifa.bousselmi@inrst.rnrt.tn

Other practises of local management are present in daily behaviour. An example is the use of the wastewater from washing clothes for wiping the house, for the irrigation of the garden or as water for toilet flushing according to the possibilities and the need of the moment. The urban system and modernization as well as legislation lead to the reduction and sometimes the loss of these practices which are not re-adapted for an urban application. In addition the development of household appliances (the washing machine ...) and the implementation of the sewage system allowing the transportation of wastewaters far from their points of production have meant that people are less and less confronted with the handling of wastewater, decreasing the possibilities of local re-use and leading to a feeling of "rejection and dislike" which tends to be generalized in an urban environment.

In the frame of the Zer0-M project, a "training and demonstration centre" (TDC) is planned [2] in south Mediterranean countries (Morocco, Tunisia, Egypt) and Turkey. The purpose is to present concrete examples of the adaptation of the old practices using powerful technologies for water treatment in an urban to semi-urban context for re-use locally as a starting point for possible new developments.

Based on the technology-mediation approach [3], an investigation is conducted to assess the acceptance of the implementation of the Tunisian TDC and the related approach of treatment and local re-use¹.

In the following, a case study will be presented as well as the wastewater characteristics and the technical properties of the Training and Demonstration Centre. Subsequently, the importance of acceptance is emphasized. After a brief introduction to the questionnaire, results are reported and discussed. Finally, recommendations are deduced from the results.

PRESENTATION OF THE STUDY CASE

One of the principles of local re-use is the separation of different wastewater streams to increase the possibilities. The characteristics are in this case well identified and different which allows the adapted treatment and recycling. The segregation of effluent implies the multiplication of discharge and storage systems and the management of the different parts of the recycling unit. However, it allows water benefits which could be crucial in some arid areas. Certain urban applications are easily adaptable to the segregation of water and lead to an unquestionable benefit such as the examples aimed at by the Zer0-M project: hotels, clubs of sports, hammams and student houses [1]. Concerning the latter case, the number of student houses is important in Tunisia and they lodge a growing number of students of approximately 69,000 [4] for the year 2005, equivalent to the population of a Tunisian city. The student house buildings present a facility of segregation of grey and black water since the showers or toilets are

1 The study on acceptance was funded by the HANS-SAUER-FOUNDATION (www.hans-sauer-stiftung.de).



Fig. 1: GENERAL VIEW OF STUDENT HOUSE BUILDING

grouped in one space for common use. In addition these buildings have an important roof surface for rain-water harvesting.

The student house selected for the installation of the TDC is a public building of three floors for female engineering students (Fig. 1) with a capacity of 212 persons. The bath area is equipped with 18 showers and situated on the ground floor. Each floor has 10 wash-hand basins and five toilets.

CHARACTERIZATION OF WASTEWATERS

Water demand on only the ground floor is recorded during one week. Water demand for toilet and hand washing basins is related to 26 students, water for bathing should be linked to all of the students. The average is 14 m³/day. It is clear that a longer period is necessary to identify specific water consumptions. A cyclic consumption of bathing water is observed and connected to the availability of hot water; the average for grey water is 8 m³/d.

Fresh grey water produced in the showers, and black water from the toilets was sampled for analysis. Their average qualities are presented in Fig. 2 and compared to municipal wastewater taken from very close sites corresponding to the effluent of the pilot plant of Water Researches and Technologies Centre (CERTÉ) which is connected to the sewage system [5]. High COD, BOD and TSS fluctuations are observed. As underlined by other authors, the black water contains the greatest part of organic pollution (COD, BOD) as well as faecal bacteria compared to grey water.

Fig. 2: AVERAGE QUALITY OF GREY (GW), BLACK (BW) AND MUNICIPAL WASTE-WATER (MWW)

PRESENTATION OF THE TRAINING AND DEMONSTRATION CENTRE

The TDC scheme is divided into three lines of treatment relating to grey water, black water and rain water

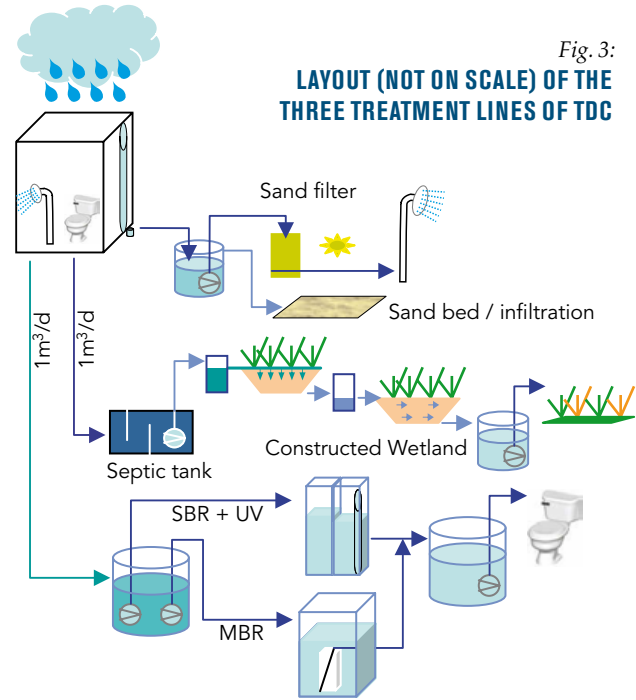
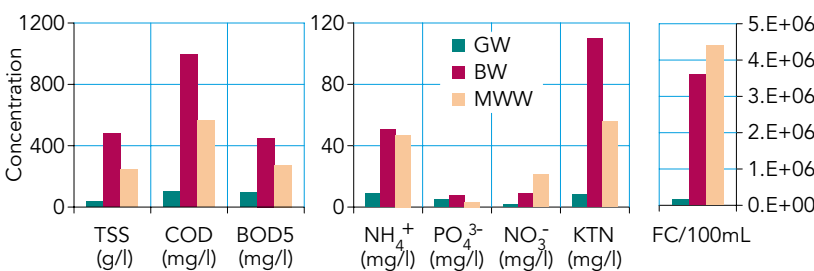

Fig. 3:

LAYOUT (NOT ON SCALE) OF THE THREE TREATMENT LINES OF TDC

and three objectives of re-use for toilet flushing, landscaping and showering, respectively. Technologies to be established are membrane bioreactor MBR, (BUSSE GmbH, Germany), sequencing batch reactor SBR (PONTOS GMBH, Germany) and Constructed Wetland (Fig. 3). Research studies are conducted by Zer0-M partners to optimize and evaluate the performances of these technologies with respect to grey or black water.

Grey Water: The grey water is first introduced from a manhole to a tank serving as a storage and homogenizing unit. Coarse and fine particles are removed by screens placed in the manhole and the holding tank. The designed flow is 1 m³/d. Two technologies of treatment are selected, MBR and SBR. The principle of the SBR is a biological treatment in a compact reactor with different sequences (example: aerobic/anoxic/settle-ment) of which the order, the number and the duration are variable and have to be optimized according to the nature of the effluent. The tests of optimization carried out in the laboratory on SBR demonstrate an elimination of 90% of the COD and N-NH₄⁺ [6]. The disinfection of treated water is ensured by an UV lamp.

The MBR is a technology with a high investment cost in comparison with the SBR but more compact and ensuring a high quality of treated water allowing recycling. It combines activated sludge treatment for the removal of bio-degradable pollutants and a membrane for solid/liquid separation. Its application on the laboratory scale demonstrates that MBR technology is adapted to treat grey water and the permeate characteristics fit standards for recycling for toilet flushing and present an excellent aesthetic aspect [7]. However, the authors underlined that the flux should be increased; if not the re quired membrane area and associated costs will be high. The application of the MBR (BUSSE) to raw grey water, including kitchen wastewater, confirmed that the submerged membrane bioreactor was appropriate for grey water treatment with the purpose of reuse [8].

Black water: The black water is introduced to a storage tank and then 1 m³/day is treated in a three-chamber septic tank followed by vertical subsurface flow (VSSF) and horizontal subsurface flow (HSSF) constructed wetland. This combination called hybrid systems is considered powerful, leading to a mean removal rate of COD 94%, BOD5 95% [9]. The treated water is stored in a tank for green area irrigation.

Rain water: The rainwater is collected from the roof of the student house building (approximately 600 m²) in a storage tank (14 m³) after screening. The outflow of the storage tank discharges into a sand bed for rainwater infiltration. The pumped water is filtered with sand filter and heated using solar energy before being recycled to supply one shower. The technology is inexpensive with a good effluent quality for use. Sludge produced by the TDC is treated in a planted composting bed.

ACCEPTANCE BY THE STUDENTS

For several reasons, it is important that the students accept the new conditions. Although the students do not have a lot of possibilities to express dissatisfaction, their cooperation is nevertheless a necessary condition for the sustainable use of the station: Regarding the showers, for example, only one of them will be operated with treated rainwater, the others are fed with regular tap water. In case the students do not accept showering with treated rainwater, this one shower might simply not be used. The chances that the TDC will be maintained from the administration of the residence hall are bigger if there are no problems with student satisfaction. Moreover, it is the objective of Zer0-M to spread knowledge about sustainable water management. 212 engineering students who get to know and might appreciate different methods of water treatment and reuse are a big chance for the project which should be seized. Once they are convinced of the approach, they might function as multipliers of ecosan techniques.

Finally, in the sense of participatory approaches, asking for the students' opinions is simply a matter of respect. The sanitary conditions in the residence hall directly concern their everyday lives, and their worries and concerns should be taken seriously.

INVESTIGATION METHOD

A questionnaire was designed to assess the students' opinions of the water treatment plant. As mentioned above, three major changes will be taking place for the students, that is, changes concerning toilet flushing, showering, and irrigation. For each of the three domains, several questions were asked, such as "It is a good idea to flush the toilets with treated water from the showers"; "It is a good idea to use treated rainwater for the showers"; "It is a good idea to irrigate the green spaces around the residence hall with treated water from the toilets". Where possible, the same phrasing

was used for the three domains to allow for comparison. Answers were given on a five point rating scale. If not otherwise stated, a smaller numeric value means greater agreement with water reuse.

There were also questions on the students' wish to be involved in issues that concern the residence hall and to get more information on water saving and the water quality of the treated water used for toilets, showers, and irrigation in the future.

Finally, two items aimed at the students' trust in the engineers who planned the station, and in the administration of the residence hall: "I am convinced that the engineers who plan the water treatment plant (the managers of the residence hall) know what they are doing." Again, answers could be given from "I fully agree" to "I do not agree at all".

About a hundred questionnaires were distributed to the women living in the residence hall. Of these, 47 were returned. Due to a misunderstanding, several questionnaires were handed out to students who did not live in the residence hall but were just visiting. In 15 of the questionnaires, the students' responses to the question how long they had been living in the residence hall indicated that they did not live in the residence hall at all so they had to be excluded from further analysis. One of the remaining questionnaires was excluded because the answers strongly suggested that the questionnaire was not thoroughly read and completed (every single item was answered with "1").

That is, 31 questionnaires are included in the final analysis. The women are between 20 and 26 years old, with a mean (M) of 22.8 years and a standard deviation (SD) of 1.9 years. They have been living in the residence hall between 1 and 81 months (M=35 months, SD=21.3 months).

MAIN RESULTS OF THE INVESTIGATION

In general, the students reported quite positive attitudes towards the planned toilet flushing, showering, and irrigation methods. On average, responses are around 2 or 2.5 which is above average on a scale from 1 to 5. Several items are presented exemplarily: Flushing the toilets with treated water from the showers, showering with treated rainwater, and irrigating the green spaces around the residence hall with treated water from the toilets was seen as rather positive², with means ranging from 1.63 to 2.00 (Fig. 4, upper diagram). Similarly, the students agreed quite a lot that it was a good idea to flush the toilets with treated water from the showers, to use treated rainwater for the showers, and to irrigate the green spaces around the residence hall with treated water from the toilets³; here, the means ranged from 1.77 to 2.13 (Fig. 4, lower diagram).

Comparing the three domains, toilet flushing, showering, and irrigation, it becomes obvious that shower-

2 on a scale ranging from 1=positive to 5=negative

3 on a scale ranging from 1=I fully agree to 5=I do not agree at all

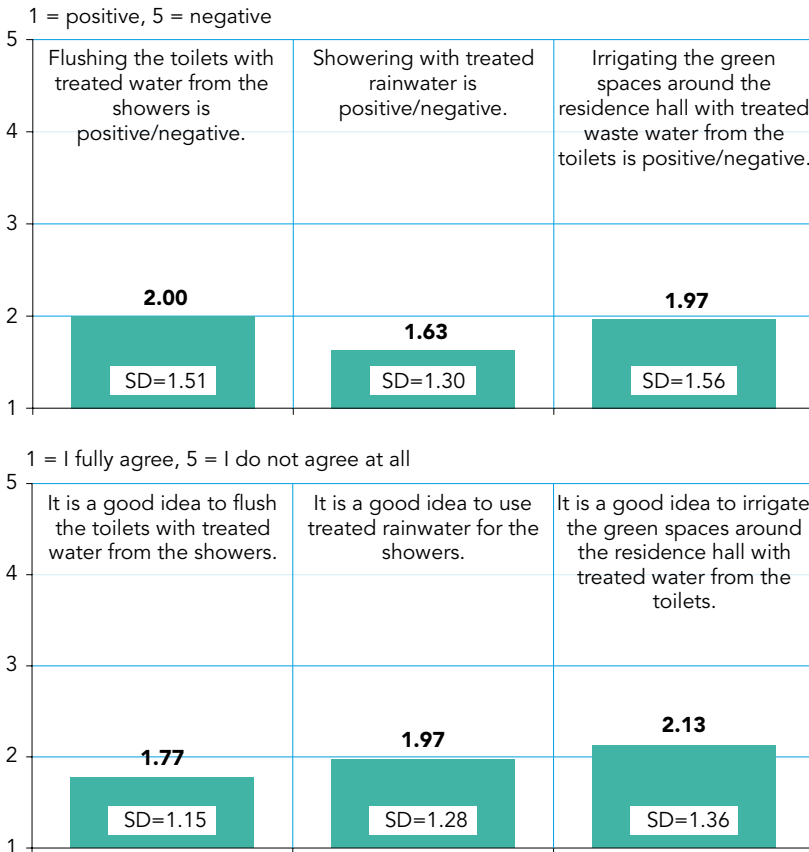

Fig. 4: STUDENTS' AGREEMENT TO WATER REUSE (MEANS AND STANDARD DEVIATIONS)

ing with treated rainwater is most agreed to by the students: It is found more positive, more useful, more hygienic and less disgusting⁴ than toilet flushing with treated grey water and irrigation with treated black water.

The students seem to be worried about health-related issues (Fig. 5). Since this question is inversely phrased, a smaller score indicates the students being more worried; results between 2.23 and 2.81 indicate that the students are quite worried⁵. Congruent with the findings reported above, the idea to shower with treated rainwater induces fewer concerns than the measures concerning toilet flushing and irrigation.

Fig. 5: STUDENTS' CONCERNS ABOUT HEALTH RISKS (MEANS AND STANDARD DEVIATIONS)

Strong agreement was found with regard to the statements that the students should be included in the planning process (M = 1.65, SD = 1.38) and that they would like to get more information on the quality of the water used for the toilets, showers, and for irrigation (M = 1.74, SD = 1.32)⁶.

Finally, the students reported a medium amount of trust in the planning engineers (M = 2.65, SD = 1.50) and

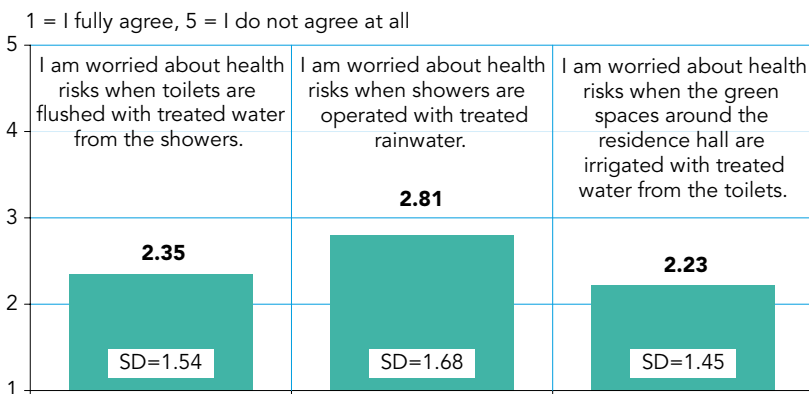

in the managers of the residence hall (M = 2.90, SD = 1.62). Several statistically significant positive correlations were found between both trust in the engineers and trust in the managers of the residence hall on the one hand and agreement to the water reuse measures on the other hand. For example, the more trust in the engineers the students reported, the more positive did they think flushing the toilet with treated from the showers was⁷; the more the students trusted in the managers of the residence hall, the more did they agree to the phrase that showering with treated rainwater was a good way to save water⁸.

DISCUSSION AND CONCLUSION

In general, it seems that the students do approve of the water reuse approach in their residence hall. They are sensitised to the necessity to save water, and they have quite positive attitudes towards flushing the toilet with treated grey water, irrigation with treated black water, and especially, towards showering with treated rainwater. This may be due to the fact that as Tunisian students of engineering, they are well aware of the problem of water scarcity, and they have confidence in technical solutions. Interestingly, despite this general agreement, the students are worried about health risks related with the planned water reuse. Face-to-face conversations with some of the students suggest that they are worried because they do not know anything about the water quality of the reused water. In line with this, the students are strongly interested in information on the water quality.

Although the correlations between trust in the engineers and managers of the residence hall do not allow the conclusions of causality it might be possible that the attitudes of the students towards the water reuse measures are influenced by the degree of trust they feel towards the engineers and the administration of the residence hall.

It is recommended to develop a leaflet with information on the project and distribute it to the students before construction works start. This leaflet should include information on Zer0-M, the ecosan approach, on the properties and the purpose of the TDC and on the consequences it may have for the students. Possible health risks should be discussed. Also, it should be pointed out in the leaflet who is responsible for the pro-

4 Due to large variances, a two-tailed Wilcoxon test only revealed significance (p05) for showering with treated rainwater being less disgusting than irrigation with treated black water and marginal significance (p10) for showering with treated rainwater being more hygienic than flushing the toilets with treated water from the showers and for showering with treated rainwater being less disgusting than flushing the toilets with treated water from the showers.

5 on a scale ranging from 1=I fully agree to 5=I do not agree at all

6 on a scale ranging from 1=I fully agree to 5=I do not agree at all

7 one-sided Spearman's rank correlation, r = .446, p = .008

8 one-sided Spearman's rank correlation, r = .386, p = .016

ject, including contact information in case there are questions. As soon as it is available, data from the water analysis can be put on the black board of the residence hall.

The leaflet is supposed to enhance acceptance in two ways: by providing information, it can reduce the students' concerns about health issues. Furthermore, it is apt to increase trust in the engineers who are in charge of the project by showing the students that their concerns are taken seriously. Trust, again, is related to acceptance.

As the users of the treated wastewater, the students play an important role in the TDC. Their acceptance and satisfaction have a major impact on the sustainable use of the station. The results show that even in a population where there is a general understanding and acceptance of the ecosan approach, there is still a need to be informed and involved. A second survey will be conducted after the implementation of the station to further investigate issues of acceptance.

REFERENCES

- [1] Ghrabi, A. (2007). Harvesting for domestic use in Tunisia. *Sustainable Water Management Journal* (Project Zer0-M), 1-2007.
- [2] Regelsberger, M., Baban, A., Bousselmi, L., Abdel Shafy, H., El Hamouri, B. (2007). Zer0-M, sustainable concepts towards a zero outflow municipality. *Desalination*, 215, 64-72.
- [3] Arnold, F., Mieg, H., Hoffmann, C. (2007). Successful Innovation and Invention of Water Treatment Technologies Using Technology Mediation. Centre de Recherche et des Technologies des Eaux (CERTE) (Ed.), *Conference Proceedings of the MEDA WATER International Conference on Sustainable Water Management (ZERO-M)*, S. 29-32. Tunis: CERTE.
- [4] www.ooun.rnu.tn, www.oouc.rnu.tn, www.oous.rnu.tn
- [5] Ghrabi, A., Ferchichi, M., Kallali, H., Hassen, A., Jedidi, N., Bousselmi, L., Ennabi, M. (2000). Traitement des eaux usées urbaines dans une station pilote semi-industrielle. *Wastewater treatment and Reuse Adapted to the Mediterranean Area*, Proceedings of International Conference WATRAMA 2000. Tunis, 25-28 October 2000, 40-45.
- [6] Lamine, M., Bousselmi, L., Ghrabi, A. (2007). Biological treatment of grey toilets using sequencing batch reactor. *Desalination*, 215, 127-132.
- [7] Merz, C., Scheumann, R., El Hamouri, B., Kraume, M. (2007). Membrane bioreactor technology for the treatment of grey water from a sports and leisure club. *Desalination*, 215, 37-43.
- [8] Murat, S., Atasoy, E., Baban, A., Gunes, K., Ayaz, S. (2007). Grey water treatment by a membrane bioreactor and reuse options. *Meda Water Conference: Sustainable Water Management*, Tunis 21-24 March 2007.
- [9] Masi, F., Martinuzzi, N. (2007). Constructed wetlands for the Mediterranean countries: Hybrid systems for toilets reuse and sustainable sanitation. *Desalination*, 215, 44-55.



REUSE OF WASTE- WATER FOR AGRICULTURE

By DUNCAN MARA*

Wastewater reuse will have to become much more common in a world of increasing water scarcity. This article explains how we can ensure that public health is not compromised through wastewater use in agriculture and how wastewater can be best treated to protect both those who work in wastewater-irrigated fields and those who eat wastewater-irrigated foods, especially salad crops and vegetables eaten uncooked.

* Duncan Mara, School of Civil Engineering, University of Leeds, Leeds LS2 9JT, United Kingdom, d.d.mara@leeds.ac.uk

◀ Fig. 1:

UNRESTRICTED IRRIGATION OF LETTUCE AND CABBAGE

Wastewater treatment for wastewater reuse' is a concept that is being increasingly accepted in most regions of the world, both in industrialized and developing countries, but one which will dramatically increase in global importance over the coming decades. The reason for this is as simple as it is stark: the number of people living in water-stressed and water-scarce countries is increasing at a rate much greater than that of the number of people in the world (Hinrichsen *et al.*, 1998; United Nations Population Division, 2000) (Fig. 2). Where will all the water needed to produce the food for all these additional people in water-stressed and water-scarce countries come from? The answer is simple: some of it will come from existing water resources, but most will have to come from treated wastewaters. It will be (actually, it will have to be) "Freshwater for Towns and Cities, Treated Wastewater for Agriculture". Moreover, agriculture will have to be better planned in these regions: there is unlikely to be enough water to produce much meat and most of the available water, commonly in the form of treated wastewater, will have to be used to produce staple carbohydrate crops and vegetables (see Pearce, 2006). It will have to be "More Crop per Drop", the so-called 'Blue Revolution'. Actually we will need a new combined Blue and Green Revolution – better use of irrigation waters, including treated wastewaters, and better crops to irrigate.

All this means that we will have to take our wastewaters much more 'seriously'. Firstly, we all have to recognise that local wastewaters are an integral part of local water resources, and thus 'integrated water resources management' has to include wastewater management. As pointed out by Asano (2002), wastewater is a very dependable water resource and in droughts it is likely to be the most dependable.

Secondly, we will have to be much more careful with our wastewaters because they are part of our water resources: for example, we must not let them become contaminated with toxic effluents from local industries as we certainly do not want any industrial toxicants reducing our crop yields or contaminating our food (see Ayers and Westcot, 1989).

Thirdly, of course, we have to protect human health – i. e., we have to ensure that any additional risks to our health from working in wastewater-irrigated fields and/or from eating wastewater-irrigated foods are 'tolerable'.

Region:	DD incidence All ages	DD incidence 0 - 4 years	DD incidence 5 - 80+ years
Industrialized countries	0.2	0.2-1.7	0.1-0.2
Developing countries	0.8-1.3	2.4-5.2	0.4-0.6
World average	0.7	3.7	0.4

Table 1:

DIARRHOEAL DISEASE INCIDENCE PER PERSON PER YEAR IN 2000 BY REGION AND AGE (MATHERS *et al.*, 2000)

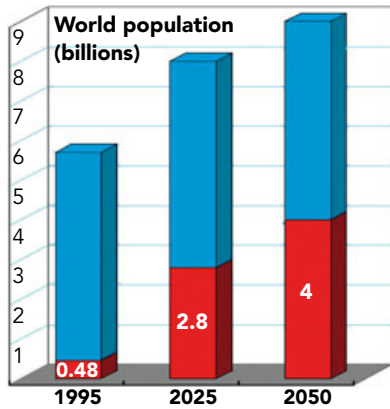

Fig. 2: **PROJECTED INCREASES IN WORLD POPULATION AND THE PART OF THE POPULATION LIVING IN WATER-STRESSED AND WATER-SCARCE COUNTRIES (RED)**

WHAT IS A TOLERABLE RISK?

We tend to be very conservative in our perception and appraisal of risk. One of the negative health outcomes we can expect when we use treated wastewaters to irrigate food crops is diarrhoeal diseases (DD). We might like to think that we should treat our wastewaters so that we never cause a single additional case of DD through wastewater reuse. But would this be sensible? After all, DD are very common indeed.

Table 1 shows the global incidence of DD in 2000. Most occurs, of course, in the under-fives, but the over-fives have a high incidence: 0.1 - 0.2 per person per year (pppy) in industrialized countries and 0.4 - 0.6 pppy in developing countries.

You could argue that an incidence rate of 0.1 pppy for people in industrialized countries, with their mostly very high levels of water supply and sanitation, is the ‘background’ DD incidence level which we are unlikely to be able to reduce significantly or, more importantly, economically (i.e., we have to recognise that, at least at the margin, ‘prevention’ may not always be cheaper than ‘cure’). So perhaps, in the future, this immediate water-scarce future, we should not be too worried if our wastewater reuse activities (which we see as essential in our water-scarce environment) increase this background rate by a small amount – but how small is small? The World Health Organization, its current Guidelines for Wastewater Use in Agriculture

Control measure	Pathogen reduction (log units)	Notes
Drip irrigation	2-4	2-log unit reduction for low-growing crops, 4-log unit reduction for high-growing crops.
Pathogen die-off	0.5-2 per day	Die-off after last irrigation before harvest (value depends on climate, crop type, etc.).
Produce washing	1	Washing salad crops, vegetables and fruit with clean water.
Produce disinfection	2	Washing salad crops, vegetables and fruit with a weak disinfectant solution and rinsing with clean water.
Produce peeling	2	Fruits, root crops.

Table 2: **PATHOGEN REDUCTIONS ACHIEVED BY POST-TREATMENT HEALTH-PROTECTION CONTROL MEASURES (WHO, 2006)**

(WHO, 2006), uses a tolerable rotavirus disease risk of 10^{-4} pppy and a tolerable rotavirus infection risk of 10^{-3} pppy. These values are based on the same tolerable additional disease burden used in its current Guidelines for Drinking-water Quality (WHO, 2004), but they are very cautious as an increase in DD incidence from 0.1 pppy to 0.1001 pppy is epidemiologically undetectable.

However, the new WHO Guidelines do say that countries are free to adopt a level of additional DD risk greater than 10^{-4} pppy – say, 10^{-3} pppy. Adopting this lower level of disease risk would still protect public health and it also means spending less money on wastewater treatment. Given that most of the wastewaters currently used to irrigate food crops are untreated, this should be seen as a major advantage as it would permit a country to at least start using its wastewaters productively in a much safer way.

TOLERABLE RISK AND CORRESPONDING REQUIRED EFFLUENT QUALITIES

The tolerable additional rotavirus infection risk of 10^{-3} pppy is equivalent to a required pathogen removal of 3 \log_{10} units for restricted irrigation and 6 - 7 \log_{10} units for unrestricted irrigation (Mara *et al.*, 2007; WHO, 2006).

RESTRICTED IRRIGATION

For restricted irrigation (i. e., the irrigation of all crops except food crops eaten uncooked) the 3-log unit has to be achieved solely by wastewater treatment. In warm climates an anaerobic pond followed by a secondary facultative pond and a single maturation pond will achieve a 3-log unit pathogen reduction and also, in most situations, an effluent with ≤ 1 human intestinal nematode egg per litre (see Mara, 2004) (see Fig. 3 and Fig. 4). The 3-log unit pathogen reduction refers to bacterial, protozoan and viral pathogens and, for design purposes, it is broadly equivalent to a 3-log unit reduction of *E. coli*.



Fig. 3: **THIS YOUNG MEXICAN BOY IS WORKING BAREFOOT IN A FIELD OF BEANS IRRIGATED WITH UNTREATED WASTEWATER - HE IS PARTICULARLY AT RISK FROM HOOK-WORM INFECTION**



Fig. 4: **WASTEWATER TREATMENT AND RESTRICTED IRRIGATION IN VALLE DEL CAUCA, SOUTHWEST COLOMBIA: THE WASTEWATER FROM THE SMALL TOWN OF GINEBRA IS TREATED IN AN ANAEROBIC POND AND A SECONDARY FACULTATIVE POND AND THE EFFLUENT USED TO IRRIGATE SUGAR CANE**

UNRESTRICTED IRRIGATION

The same treatment system as for restricted irrigation is suitable for unrestricted irrigation (i. e., the irrigation of all crops, including food crops eaten uncooked) (see Fig. 1) if post-treatment health-protection control measures (Table 2) are in place to provide additional pathogen reductions totalling 4 log units. This is very easily achieved: for example, by the drip-irrigation of low-growing crops (e.g., lettuce, onions; see Polak *et al.*, 1997, and Intermediate Technology Consultants, 2003, for details of low-cost drip-irrigation systems), which provides a 2-log unit reduction, a 1-log-unit reduction due to die-off, and a 1-log unit reduction from produce washing. Die-off always occurs, so it should always be taken into account (to ignore it requires more treatment and hence more money); it is a relatively simple matter to measure typical time intervals from the last irrigation before harvest to the appearance of the produce in local shops.

WASTEWATER TREATMENT

What sort of wastewater treatment should we use? Our first choice should always be waste stabilization ponds (WSP), and we should only not use WSP if, in any given situation, they are not the least-cost solution. Why WSP? Because they are a low-cost, low-maintenance but high-efficiency system, and for wastewater reuse this high efficiency relates to their very high removals of excreted pathogens. WSP are generally the cheapest and the best method of wastewater treatment, especially in warm-climate countries (see Mara, 2004). People who advocate treatment systems other than WSP, especially prior to reuse for crop irrigation, are either ignorant of them or wish to sell more expensive solutions. They use various arguments against WSP, including too high a land area requirement and odour. Both are specious arguments. Arthur (1983) showed that WSP were cheapest up to land prices of USD 50,000 - 150,000 per ha (depending on the discount rate used), and Tsagarakis *et al.* (2001) found that they were cheapest in Greece up to a land price of USD 300,000 per ha. Thus, if an honest appraisal is done (see Arthur, 1983, for the appropriate appraisal methodology), WSP are not necessarily disadvantaged by high land prices (and we should remember that money spent on land is an investment, whereas money spent on electricity, for example for aeration in activated sludge basins, is money gone forever). WSP (anaerobic and facultative ponds) only smell if they have been badly designed, if they are organically overloaded or if the local drinking water contains too much sulphate, so they are not so different in this respect from other more expensive treatment systems.

CONCLUDING REMARKS

We have to learn to treat and use wastewater more wisely. We need to have a much better understanding of the risks involved as well as the benefits; and, especially if we are poor, we need to be make sensible decisions regarding risk, treatment and reuse (if we are rich, we can afford to make mistakes). Wastewater treatment engineers need to work with agricultural engineers and farmers. All this may be different from what we do now, but it is not difficult. Our 'water world' is changing, and so must we.

REFERENCES

- Arthur, J.P. (1983). Notes on the Design and Operation of Waste Stabilization Ponds in Warm Climates of Developing Countries (Technical Paper No. 7). Washington, DC: The World Bank.
- Asano, T. (2002). Water from (waste)water ? the dependable resource. *Water Science and Technology* 45(8), 23-33.
- Ayers, R.S. and Westcot, D.W. (1989). *Water Quality for Agriculture* (Irrigation and Drainage Paper No. 29, rev. 1). Rome: Food and Agriculture Organization.
- Hinrichsen, D., Robey, B. and Upadhyay, U.D. (1998). Solutions for a Water-Short World (Population Reports, Series M, No. 14). Baltimore, MD: School of Public Health, Johns Hopkins University.
- Intermediate Technology Consultants (2003). *Low Cost Micro-irrigation Technologies for the Poor*. Rugby: Intermediate Technology Consultants.
- Mara, D.D. (2004). *Domestic Wastewater Treatment in Developing Countries*. London: Earthscan Publications.
- Mara, D.D., Sleigh, P.A., Blumenthal, U.J. and Carr, R.M. (2007). Health risks in wastewater irrigation: comparing estimates from quantitative microbial risk analyses and epidemiological studies. *Journal of Water and Health* 5(1), 39-50.
- Mathers, C.D., Stein, C., Ma Fat, D., Rao, C., Inoue, M., Tomijima, N., Bernard, C., Lopez A.D. and Murray, C.J.L. (2002). *Global Burden of Disease 2000, Version 2: Methods and Results*. Geneva: World Health Organization.
- Pearce, F. (2006). The parched planet. *New Scientist* 189(2540), 32-36.
- Polak, P., Nanes, B. and Adhikari, D. (1997). A low-cost drip-irrigation system for small farmers in developing countries. *Journal of the American Water Resources Association* 33, 119-124.
- Tsagarakis, K.P., Mara, D.D. and Angelakis, A.N. (2003). Application of cost criteria for selection of municipal wastewater treatment systems. *Water, Air and Soil Pollution* 142(1-4), 187-210.
- United Nations Population Division (2000). *World Population Nearing 6 Billion Projected Close to 9 Billion by 2050*. New York, NY: Population Division, Department of Economic and Social Affairs, United Nations.
- WHO (2004). *Guidelines for Drinking-water Quality*, 3rd ed. Geneva: World Health Organization.
- WHO (2006). *Guidelines for the Safe Use of Wastewater, Excreta and Greywater, volume 2: Wastewater Use in Agriculture*. Geneva: World Health Organization.



SWM TRAINING AND DEMONSTRATION CENTER

SUSTAINABLE WATER MANAGEMENT AT TUBITAK MARMARA RESEARCH CENTER (MRC)

By AHMET BABAN, ELIF ATASOY, SELDA MURAT, KEMAL GUNES and SELMA AYAZ*

The aim of implementing TDC is the demonstration of new practices, comprising a basis for training activities as well as seminars and workshops. With this approach, gaining the ability to develop non-conventional water resources for sustainable development and helping the dissemination of knowledge through training activities and workshops would be an asset.

* AHMET BABAN (Ahmet.Baban@mam.gov.tr), ELIF ATASOY (Elif.Atasoy@mam.gov.tr), SELDA MURAT (Selda.Murat@mam.gov.tr), KEMAL GUNES (Kemal.Gunes@mam.gov.tr) and SELMA AYAZ (Selma.Ayaz@mam.gov.tr) are researchers at the TUBITAK Marmara Research Center, Chemistry and Environment Institute, 41470 Gebze, Kocaeli, Turkey

The project will benefit from the point of resource conservation and related economical aspects. TDCs are also aimed at the participation of technical staff in the training activities and workshops, especially for infrastructure, new piping installations and other related issues of SWM. They provide a possibility to gather practical experience as well as training the trainers in a very practical way. TDCs also help the technicians, as well as decision makers and media members to understand the design involved and the operation of these new concepts.

SCOPE

The development of concepts and technologies to achieve sustainable water management in Mediterranean conditions for decentralized areas is the major goal of TDC implementation. The TDC designed in MRC consisted of integrated concepts for different applications of decentralized wastewater treatment and reuse applications. In our case, the term decentralized refers to tourist facilities, rural areas (small municipalities) or suburban residential areas, not connected to central wastewater treatment plants.

As far as tourism is concerned in the Mediterranean region, this leads to high seasonal fluctuations in population and a lack of proper infrastructure which may constitute a water management problem. The situation is worsened even more by the water scarcity conditions in the region. Hence, the key elements may be described as a

- high water consumption in tourist resorts,
- a high irrigation water need for landscaping,
- wastewater treatment and reuse,
- wastewater treatment plant sludge (efficient/hygienic utilization).

Apart from tourist areas, another driving force is the need for the development of sustainable, economic and appropriate water management methodology for rural areas. Along these lines the utilization of sewage sludge for soil conditioning and energy production has to be practiced. Rainwater harvesting is believed to be a sustainable resource and worth practising. These issues were taken into account in the TDC design and operation. Moreover, considering the water scarcity potential of the Mediterranean region, low water consumption techniques are experimented with in the TDC concept.

IMPLEMENTATION OF TDC

The SWM examples installed in TDC cover a variety of measures as wide as possible, ranging from water saving equipment to wastewater recycling. As a result of varying the configurations of treatment units and other equipment it is intended to design and implement comprehensive sets. An explanation will be given below about the activities and application of technologies at the TDC built up in MRC premises in the context of the Zer0-M project.

SEGREGATION OF WASTEWATER

Grey and black water were segregated and collected from lodging houses on the TUBITAK MRC Campus. Two buildings comprising a total of 28 apartments were connected to separate holding tanks. A fine screen (3 mm mash) was installed in the tanks. Hence, the tank serves as a grey and black water storage basin and a coarse matter separator as a physical pre-treatment. Raw grey and black water characteristics were monitored based on daily composite samples taken after the screen.

Parameter	Greywater	Blackwater
pH	6.9 - 7.7	7.36 - 8.14
TSS, mg/l	48	560
BOD ₅ , mg/l	90	406
COD _T , mg/l	245	1218
TKN, mg/l	9	188
NO ₃ -N, mg/l	0	0
Tot. P, mg/l	7.3	21.26
Oil and Grease, mg/l	< 2	26
Conductivity, ms/cm	401	1767
Colour, Pt-Co	12.2	468
Tot. Coliforms /100 ml	13634	> 10E6
Fecal Coliforms /100ml	3565	> 10E6
Detergent, mg/l	0.6	-

Table 1: RAW GREY AND BLACK WATER CHARACTERISTICS (AVERAGE VALUES)

TREATMENT OF SEGREGATED WASTEWATER

As shown in Fig. 1, different treatment technologies are applied to grey and black water treatment. For greywater treatment, four different technologies will be assessed as a membrane bioreactor, sequencing batch reactor, rotating biological contactor and constructed wetlands. For the treatment of blackwater, one alternative is to combine constructed wetlands with two-stage anaerobic reactors as a primary treatment

Fig. 1:
TDC SCHEME
AT MRC

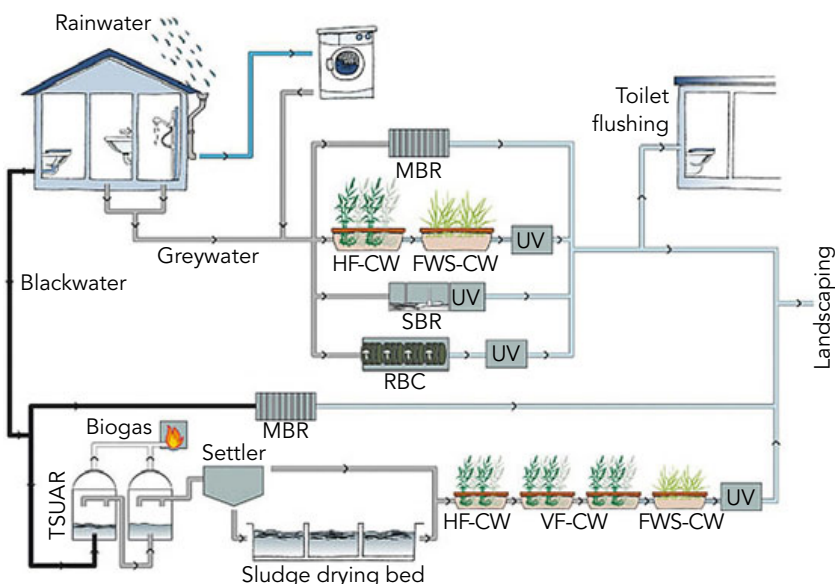

stage. The second alternative is the membrane bioreactor.

MEMBRANE BIOREACTOR SPECIFICATIONS FOR GREY AND BLACKWATER TREATMENT

Identical two pilot scale Membrane bioreactors (MBR) with an effective volume of 600L were operated in a sequencing batch mode. They were manufactured by BUSSE GmbH, Germany. Both systems include a submerged micro filtration plate and frame module (KUBOTA). The module has a nominal pore size of 0.4 μm , manufactured from Polyelectrolyte Complex (PEC) with a total membrane area of 5 m². Fouling on the surface of the plate and frame module is controlled by a tangential flow along the membrane surface and fine and coarse bubble air scouring. The trans-membrane pressure difference is provided by the water head above the membrane (gravity flow). Air is supplied to the MBRs by an air blower which also controls anoxic/aerobic conditions automatically by PLC at pre-determined and adjusted intervals.

SEQUENCING BATCH REACTOR (SBR) SPECIFICATIONS FOR GREYWATER TREATMENT

The SBR reactor (AquaCycle900) was designed and manufactured by PONTOS GmbH, Germany with an effective volume of 600L. Before the greywater enters the system, it is first filtered. The system consists of two serial tanks for biological reactions and a third tank for storage including UV hygienisation. In the first tank the water is pre-treated. After the batch time, it is pumped into the second tank for further treatment. In both tanks the water is treated under aerobic conditions. Natural bio-cultures (micro organisms) hereby settle on special, free-floating carrier material. They carry out the actual treatment work. There was no activated sludge addition in the starting up period. The bio-cultures developed and multiply automatically in the first 2 - 3 weeks of operation (during this period treated water is discharged from the by-pass).

ROTATING BIOLOGICAL CONTACTOR (RBC) FOR GREYWATER TREATMENT

The RBC process consists of disks with radial and concentric passages slowly rotating in a four serial tank and one settling tank for clarification. During the rotation, about 40% of the media surface area is in the wastewater. The rotation and subsequent exposure to oxygen allows organisms to multiply and form a thin layer of biomass. This large, active population causes the biological degradation of organic pollutants. Excess biomass shears off at a steady rate and is then carried through the RBC system for removal in a clarifier. The surface area of RBC is around 13 m².

TWO STAGE UP-FLOW ANAEROBIC REACTORS (TSUAR) FOR BLACKWATER-PRE-TREATMENT

The two stage system designed for the pre-treatment of blackwater. It consists of two anaerobic reactors and a reactor for settling. The designed up-flow velocity is 0.1 m/h, and HRT is one day. It is designed to provide about 50% TSS and BOD removal and about 40% COD removal before the constructed wetlands.



Fig. 2:
DIFFERENT TREATMENT TECHNOLOGIES AT TDC

CONSTRUCTED WETLANDS FOR GREY-WATER AND BLACKWATER TREATMENT

For the greywater treatment, the raw GW is fed to the horizontal flow CW (25 m²) by gravity flow and then as a second step it flows to a free water surface system (35 m²). The design criteria for the HF is 40 L/m²-d.

For the blackwater treatment, anaerobic pre-treated blackwater is fed first into the horizontal flow (10 m²) and then consecutively into two vertical flow systems (9*2 m²). Finally it ends up in the free water systems (35 m²). The design criteria for the HF and VFs is 17 L/m²-d.

RAINWATER HARVESTING

Rainwater is collected from the 350 m² roof of the one lodging house building and 100 m² TDC housing building. A vortex type rainwater filter (WISY WFF 150) is used for the separation of coarse matters before the storage tank. The stored rainwater will be re-used in the washing machine.

DIFFERENT PIECES OF SANITATION EQUIPMENT

For the water saving purpose and nutrient recovery, a dry urinal, a urine separation flush toilet and a bark-chip compost toilet are installed in the TDC building. The urine will be collected in a storage tank and after the appropriate storage time it will be used as fertilizer on small-scale agricultural fields. The faeces from the compost toilet will be collected in the compost bin (250 L) and after composting, it will be used as fertilizer, too.

RE-USE OPTIONS

Reuse of treated wastewater for minor domestic purposes such as flushing, watering the garden watering but also crop irrigation or landscaping are planned. Moreover, as we emphasized, rainwater harvesting and reuse options will be assessed in the TDC.

FURTHER RESEARCH AT TDC

The following research has been planned to carry out at the TDC;



Fig. 3:
CONSTRUCTED WETLANDS FOR BLACKWATER TREATMENT (VERTICAL FLOW, RECENTLY PLANTED)

- Determination of kinetics (respirometric analysis), COD fractionation for blackwater,
- Efficiency under various loading conditions,
- Compliance, monitoring with regard to national and international standards,
- Risk assessment, LCA,
- Modification of decentralized systems for local conditions,
- Optimization of design and operational conditions,
- Development of legal background for water reuse criteria for Mediterranean countries.

EXPECTED RESULTS

It is expected to obtain the following results at the end of the project activities;

- Introduction of the concept to the institutional framework of the country,
- Serving as a base for the training activities of technicians involved in the design and operation of the new concept, as well as decision makers,
- Dissemination activities, collaboration, between national and international institutions, conducting Msc., PhD and research,
- Increased opportunities for joint projects,
- To help the development of renewable and sustainable water resources to mitigate the water scarcity problem meanwhile enhancing the protection of the environment.

ACKNOWLEDGEMENTS

The Zer0-M project is funded by the European Commission under the MEDA Water Programme, project "Zer0-M" Contract-No ME8/AIDCO/2001/0515/59768.

REFERENCES

- www.zer0-m.org
- Baban, A., Gunes, K., Ayaz, S., Murat, S., Atasoy, E., Dogan, O., and Dikec, S., (2005). Sustainable water management practices in the Training and Demonstration Centre of TUBITAK-MRC, 1st Zer0-M Conference on Sustainable Water Management, Istanbul, Turkey

MEDA Water

Collège d'Alfred
UNIVERSITÉ
de GUELPH

CENTRE DE FORMATION ET DE DÉMONSTRATION DE L'IAV HASSAN II-RABAT

TRAINING AND DEMONSTRATION CENTER IAV HASSAN II-RABAT

De Bouchaïb El Hamouri et Martin Regelsberger*

Qu'est ce que le Training and demonstration Center IAV – Rabat?

Il s'agit d'une structure d'enseignement, de recherche, de démonstration et de formation continue rattachée au Département de Génie Rural (DGR) de l'Institut Agronomique et Vétérinaire Hassan II à Rabat. Elle est dotée de moyens et d'une infrastructure-pilote orientée vers l'épuration des eaux usées et leur réutilisation notamment en milieu rural. La majeure partie des investissements consentis pour l'acquisition de nouveaux équipements et pour le fonctionnement des installations a été mobilisée dans le cadre du projet MEDA Eau financé par l'Union Européenne et dans le cadre du projet partenariats Universitaires en Coopération et développement (PUCD) financé par l'ACDI (Canada).

* Prof. **Bouchaïb El Hamouri**, professeur pour le traitement des eaux usées au Département du Génie Rural de l'Institut Agronomique et Vétérinaire Hassan II (IAV), Rabat, Maroc, Tel. +00212 37 / 77 75 64 ; Fax +00212 37 / 77 75 64 ; b.elhamouri@iav.ac.ma

Dipl.-Ing. **Martin Regelsberger**, chef du département Eau chez AEE INTEC, Feldgasse 19, 8200 Gleisdorf Austria Tel. +43 (3112) 5886-50; Fax +43 (3112) 5886-51; m.regelsberger@ae.at

Mention of Authors

Prof. **Bouchaïb El Hamouri**, professor for wastewater treatment at the Department for Rural Engineering of the Institut Agronomique et Vétérinaire Hassan II (IAV), Rabat, Maroc, Tel. +00212 37 / 77 75 64 ; Fax +00212 37 / 77 75 64 ; b.elhamouri@iav.ac.ma

Dipl.-Ing. **Martin Regelsberger**, Head of the Water Department at AEE INTEC, Feldgasse 19, 8200 Gleisdorf Austria Tel. +43 (3112) 5886-50; Fax +43 (3112) 5886-51; m.regelsberger@ae.at



L'activité du centre peut être décrite en se référant aux divers types d'eau récupérés soit à partir du campus lui-même soit à partir du Club de l'Association Culturelle et Sportive de l'Agriculture (ACSA), voisin limitrophe du campus de l'IAV Hassan II.

Signalons que la ville de Rabat est située dans le Nord-Ouest du Maroc sur le littoral atlantique (latitude 30°03' N, longitude 6°46' W) à une altitude de 73 m en moyenne et la température moyenne est de 14 et 24°C respectivement pour la saison froide et saison chaude.

DESCRIPTION DE L'INFRASTRUCTURE PILOTE

L'infrastructure pilote comporte des réseaux de collecte et de recyclage des eaux épurées, trois unités d'épuration, deux prototypes de technologie compacte à boues activées l'un à membrane et le second un réacteur biologique séquentiel, un terrain réservé aux expérimentations sur l'irrigation (réutilisation eau et boues) et sur l'arrosage des espaces verts et un laboratoire d'analyse des eaux.

LES RÉSEAUX

RÉSEAU «EAUX MIXTES»

Par eau mixte, il est entendu une eau usée telle qu'elle existe dans la plupart des ménages où les eaux des lavabos, de la baignoire, des douches, du bidet, de la lessiveuse, de la cuisine et des toilettes sont réunies dans la même conduite d'évacuation.

Le réseau «eau mixte» collecte les eaux usées de l'ACSA et celles du campus. Ces dernières englobant la résidence des étudiants, les locaux de l'administration, ceux réservés à l'enseignement et les laboratoires de recherche. Deux grands restaurants sont exploités l'un pour les étudiants et le second au niveau de l'ACSA. Les eaux usées sont interceptées à la sortie du campus avant le rejet dans le réseau municipal puis pompées sur 1000 m et 11 m de dénivelée jusqu'au site de la station d'épuration des eaux usées «STEP eau mixte».

RÉSEAU «EAUX GRISES»

Le réseau «eau grise» est réalisé au niveau de l'ACSA, les eaux grises étant définies comme celles issues des lavabos, de la baignoire, des douches et de la lessiveuse; celles provenant des toilettes, du bidet et de

la cuisine, les «eaux noires», sont récupérées séparément à l'aide d'une seconde conduite d'évacuation.

Dans le cas de ce projet, les eaux grises sont exclusivement issues des douches associées à la salle de gymnastique du club. Ces eaux sont collectées puis acheminées à l'IAV pour être épurées dans trois systèmes différents:

- Filtre planté de roseaux + filtre à sable + désinfection UV
- Unité compacte type «réacteur membranaire»
- Unité compacte réacteur biologique séquentiel.

Le filtre planté est situé dans le site expérimental de la station d'épuration eau mixte et les deux machines compactes dans le laboratoire du Département de génie rural (DGR).

RÉSEAU DE STOCKAGE ET DE RECYCLAGE DES EAUX GRISES

Les eaux grises épurées et désinfectées sont stockées puis recyclées vers les chasses de toilettes du DGR (ces eaux auront, en bout de cycle, servi trois fois consécutives la première comme eau de douche, la deuxième comme eau de chasse d'eau et la troisième comme eau mixte épurée réutilisée en irrigation ou en arrosage des espaces verts).

RÉSEAU DE COLLECTE DE L'EAU DE PLUIE DE LA TOITURE DU DGR

Un réseau de collecte et de stockage des eaux de pluies de la toiture du DGR est mis en place en vue d'une utilisation de ces eaux pour les nettoyages divers et la chasse d'eau des toilettes. Des recherches sur leur qualité seront menées pour déterminer si elles pourront être utilisées comme eau de cuisine et de boisson.

LES INSTALLATIONS D'ÉPURATION

Les installations construites sont adaptées au type d'eau comme expliqué plus haut qui sont l'eau mixte et l'eau grise.

ÉPURATION DES EAUX MIXTES

La quantité d'eau mixte récupérée atteint $60 \text{ m}^3/\text{jour}$ dont 50 sont épurés dans la station d'épuration (STEP) «réacteur anaérobie et chenal algal» et $10 \text{ m}^3/\text{jour}$ dans la STEP «filtre planté de roseaux, type hybride V/H/V (écoulement Vertical/écoulement Horizontal/écoulement Vertical nitrification/dénitrification)». Ce partage est appelé à évoluer rapidement vers un rapport de $40 \text{ m}^3/\text{j}$ pour la première et 20 pour la deuxième filière de traitement.

Réacteur anaérobie-chenal algal-maturation

La STEP comporte deux parties

- Unité de prétraitement ou RAFADE

Le prétraitement développé à l'IAV est un réacteur anaérobie à flux ascendant et à deux étapes (RAFADE, figure 1) entièrement couvert. Il s'agit de deux bassins



Figure 1:
**PRÉTRAITEMENT
PAR DIGESTION
ANÉROBIE, RAFADÉ**

de forme cylindrique placés en série et ayant un diamètre de 3 m et une profondeur de 5 m.

Le biogaz est collecté du RAFADÉ à l'aide de deux coupoles fabriquées en polyester résistant aux acides. La base de ces couvercles est insérée dans un canal qui entoure le réacteur et qui a 0,40 m de large et 0,40 m de profondeur qui sert de joint d'étanchéité. Ce canal est rempli d'effluent épuré recyclé (voir El Hamouri 2004 et El Hafiane and El Hamouri, 2005).

- Unité de post-traitement:

L'unité de post-traitement comprend un chenal algal et un bassin de maturation.

- Chenal algal

Le chenal utilisé dans le TDC a une surface de 395 m^2 et une profondeur de 0,50 m. Le temps de séjour est de 3 jours environ (voir figure 2).

- Bassin de maturation

Un seul bassin de maturation est adopté avec les dimensions de $17 \text{ m} \times 7 \text{ m}$ et une profondeur de 1 m d'eau

Figure 2:
**VUE DU CHENAL
ALGAL**





Figure 3:
**FILTRE PLANTÉ
PRÉTRAITEMENT,
ÉCOULEMENT
VERTICAL**

et un temps de séjour de 1,5 jour (voir El Hamouri 2004 et El Hafiane and El Hamouri, 2005).

Filtre planté de roseaux (hybride-V/H/V) avec nitrification/dénitrification

Cette station reçoit l'eau usée brute après dégrillage et dessablage. Elle est alimentée par bâchées grâce à un siphon auto-amorçable capable de délivrer un volume de 1.6 m³ en 6 minutes. La STEP comporte trois stades consécutifs:

- Le premier stade est formé de trois filtres placés en parallèle, à écoulement vertical et plantés de *Phragmites australis*. Chacun des trois filtres est alimenté d'eau usée brute pendant 4 jours consécutifs avant d'être mis au repos pendant 8 jours (voir figure 3).
- Le second stade comporte trois filtres à écoulement horizontal en parallèle dont deux sont plantés de phragmites et un sans plantes pour servir de témoin (voir figures 4).

Figure 4:
**FILTRE PLANTÉ
ÉCOULEMENT
HORIZONTAL**



- Le troisième stade (stade de nitrification) est à écoulement vertical non planté. L'effluent de ce troisième stade est partagé en deux parties égales (50/50) dont une partie est recyclée sur les filtres horizontaux pour dénitrification.

EPURATION DES EAUX GRISES

L'eau grise est épurée dans trois systèmes différents:

- **Filtre planté – filtre sable-désinfection UV (8 m³/j)**
Le système est constitué de deux compartiments. Le premier consiste en un filtre gravier à flux horizontal planté de *Phragmites australis* (figure 5) alors que le second est un filtre de sables multicouches à flux vertical.



Figure 5:
FILTRE PLANTÉ POUR LE TRAITEMENT DES EAUX GRISES

- **Réacteur à membrane (membrane bioreactor, MBR)**

Il s'agit d'une unité compacte BUSSE ayant les caractéristiques suivantes:

Volume traité:	~ 675 L
Nombre de cycles:	8/j
Durée du cycle:	3 heures
Temps de contact:	25 min
Bloc membrane	
Surface:	5 m ²
Diamètre nominal des pores:	0,4 μm
Complexe de Polyélectrolytes (PEC) COBOTA	

- **Réacteur biologique séquentiel (Sequencing batch reactor, SBR)**

Il s'agit d'une unité compacte de marque PONTOS AquaCycle 900 ayant les caractéristiques suivantes:

Volume traité:	~ 850 L/j
Nombre de cycles:	7/j
Temps de réaction:	3 h
Mode d'aération:	5 min d'aération + 3 min sans aération
Durée de sédimentation:	20 min
Intervalle d'extraction des sédiments:	4 j
Temps de préchauffage de la lampe UV: ...	2 mn

TERRAIN D'EXPÉRIMENTATION -IRRIGATION ET ARROSAGE DES ESPACES VERTS-

Un terrain juxtaposant le site des STEP ayant une superficie d'1 ha est équipé d'un réseau d'irrigation alimenté en eau épurée. Il permet de mener des expérimentations sur la réutilisation des eaux en irrigation et en arrosage des espaces verts. Les expérimentations sur l'utilisation des boues stabilisées vont également être menées sur le site.

LABORATOIRE D'ANALYSE DES EAUX

Le laboratoire est situé dans le bâtiment du DGR. Il est équipé pour le suivi des performances des STEP. Les réacteurs MBR et SBR sont placés dans ce laboratoire pour les mettre dans les conditions de fonctionnement pour lesquelles ils ont été mis au point, à savoir les sous-sols d'habitations individuelles ou d'hôtels. Des analyses complémentaires relatives au sol et aux plantes peuvent être effectuées dans les laboratoires du Service des Expérimentations, des Essais et de la Normalisation (SEEN) de la Direction de Développement et de Gestion de l'Irrigation (DDGI) de l'Administration du Génie Rural (Ministère de l'Agriculture et du Développement Rural).

STAGES, DÉMONSTRATIONS ET FORMATION CONTINUE

STAGES

De nombreux stagiaires nationaux et étrangers, provenant d'Allemagne, du Canada, d'Espagne, de Tunisie et des USA, séjournent dans le TDC-IAV de Rabat. Les institutions qui financent ces stagiaires trouvent dans le TDC de Rabat la complémentarité entre:

- Installations prototype (un cran au-dessus des pilotes de laboratoire),
- une eau usée disponible et variée (eau mixte, eau grise)
- laboratoire d'analyse des eaux.

En même temps, le TDC accueille annuellement de trois à six étudiants de dernière année de l'IAV spécialité Génie Rural pour leurs travaux de fin d'études.

VISITES DES DÉCIDEURS, DES RESPONSABLES ADMINISTRATIFS ET DES OPÉRATEURS PRIVÉS

Des visites sont régulièrement organisées pour des présidents de Conseils Municipaux (maires), pour des responsables de l'Administration centrale et régionale ainsi que pour des représentants des opérateurs privés du secteur de l'assainissement liquide. L'objet de telles visites étant de montrer aux visiteurs le rôle que peuvent jouer des projets comme Zer0-M dans l'introduction de nouvelles approches et de nouveaux concepts pour la gestion des ressources en eau et de



Figure 6:
**COURS DE
FORMATION
CONTINUE,
TRAVAUX
PRATIQUES AU
LABORATOIRE
DU DGR**

l'assainissement liquide. Ils ont en même temps l'occasion de se rendre compte des nouvelles techniques et de leurs avantages en matière de gestion économe de l'eau. Les ingénieurs de demain et les chercheurs doivent, dès à présent, prendre en compte ces concepts afin de les mettre en œuvre quand ils seront imposés par la rareté de la ressource.

COURS DE FORMATION CONTINUE

Des cours de formation continue pour ingénieurs et techniciens sont organisés chaque année avec des thèmes centrés notamment sur l'assainissement écologique durable et sur les solutions adaptées au monde rural. Le cours organisé en mai 2007 (figure 6) intitulée «Collecte, épuration et réutilisation des eaux usées des communautés rurales» était notamment animé par Duncun Mara (Université de Leeds, UK), Edward McBean et Christopher Kinsely (Université de Guelph, Canada), Pascal Molle (Cemagref-Lyon) et Martin Regelsberger (AEE INTEC, Autriche).

La particularité des cours de formation continue organisés par le TDC-IAV est la possibilité offerte aux participants de travailler sur les installations d'épuration, de prélever des échantillons, de les analyser et d'établir eux-mêmes les performances de ces installations. De plus, le travail pratique donne une idée précise des détails techniques de ces installations ainsi que de leur gestion quotidienne que les cours théoriques rendent rarement.

MONITORING

Le monitoring pour la détermination des performances des filières ainsi que le suivi du comportement des ouvrages d'épuration (durabilité) est une tâche quasi quotidienne au TDC de Rabat. Ce programme de monitoring est accordé avec les autres partenaires exploitant un TDC.

MESURES *in situ*

Des appareils portatifs (oxymètres, conductivimètre, pH-mètre etc) sont utilisés pour le suivi de certains paramètres de pollution dans les ouvrages.

ECHANTILLONNAGE ET ANALYSES EN LABORATOIRE

Des campagnes de prélèvement d'échantillons (échantillons ponctuels ou composites) sont organisées toutes les semaines en fonction des capacités d'analyses du laboratoire et des besoins des étudiants-chercheurs.

À côté des paramètres physico-chimiques d'importance, un suivi bactériologique et parasitologique des eaux grises et des eaux mixtes traitées est adopté. Il s'agit là de l'une des composantes principales du programme de monitoring du TDC car ce sont les concentrations des coliformes fécaux et des œufs d'helminthes qui les premiers attirent l'attention des utilisateurs pour des raisons évidentes de santé publique.

L'APPROCHE DÉCENTRALISÉE DE L'ASSAINISSEMENT LIQUIDE EST-ELLE POSSIBLE?

La réponse est oui. En effet, l'expérience du TDC de l'IAV Hassan II de Rabat, menée depuis 1997, démontre que le concept de la station satellite, indépendante est avantageux. Construites au milieu du tissu urbain, ce type d'installations ne nuit pas à l'environnement local et permet de garder l'eau mobilisée dans la zone concernée. De cette façon, le coût d'une réutilisation des eaux usées épurées en milieu urbain pour l'arrosage des espaces verts et le lavage de la voirie se trouve réduit. En effet, cette approche permet d'éviter le pompage sur de longues distances pour ramener l'eau épurée des STEP généralement éloignées des tissus urbains.

Un deuxième niveau de décentralisation s'ouvre avec la collecte séparée des eaux grises, comme pratiquée au club de l'ACSA. Le traitement de ces eaux très légèrement polluées demande peu d'espace et peut se faire à domicile, dans des immeubles ou des bâtiments du tourisme. Les eaux épurées sont aptes à la réutilisation à des fins domestiques, comme le démontre le DGR dans les toilettes de son bâtiment. Ces toilettes fonctionnent sans problème depuis plus d'un an maintenant avec de l'eau grise épurée et désinfectée. Cette option sera à examiner notamment pour les centres ruraux à population dense. Un projet pilote de ce type est actuellement en préparation et sera à observer de près. C'est également une option pour tous les bâtiments touristiques. À long terme il sera même envisageable de chercher des solutions pour l'intégration de cette technique dans les zones urbaines, au cours de travaux de réhabilitation de bâtiments ou de quartiers par exemple.

D'autres techniques décentralisées seront probablement nécessaires dans le monde rural proprement dit, notamment en ce qui concerne le traitement des matières fécales à domicile, dans le cas où il n'y a pas de système de collecte des eaux usées. Le projet Zer0-M travaille sur ces techniques également. Une toilette à compost sera implantée dans le TDC-IAV.

CONCLUSION

Le TDC-IAV sert de démonstration pour une nouvelle approche de recyclage et de gestion économe des eaux et des substances nutritives provenant de ménages. Des exemples de nouvelles techniques, à une échelle réelle mais dans un contexte de recherche et de monitoring étroit sont installés et exploités. Des séminaires et des travaux d'étudiants-chercheurs permettent la diffusion de ces techniques, de façon d'autant plus efficace que les installations peuvent être visitées, testées et mises à l'épreuve sur place par les participants.

Les TDC permettent en même temps à la recherche dans ce domaine de développer de nouvelles solutions et une approche adaptée à la situation locale et aux problèmes rencontrés au Maroc et dans les pays limitrophes.

À long terme, ces recherches doivent mener au développement d'une gestion de l'eau à domicile et des techniques sanitaires adaptées aux pays de la Méditerranée, déterminées par la rareté de l'eau, plutôt que d'emprunter des techniques de régions dont la caractéristique principale est une surabondance d'eau. Le TDC-IAV est une unité de recherche parmi quatre dans le projet Zer0-M, les autres se trouvant en Turquie, en Egypte et en Tunisie. Grâce à la coopération de plusieurs pays Méditerranéens au projet des échanges ont été possibles dont les effets se prolongeront au-delà de la durée du projet Zer0-M.

REMERCIEMENTS

Les auteurs tiennent à remercier la Commission de l'Union Européenne, l'Agence Canadienne pour le Développement International (ACDI) et le Gouvernement du Maroc pour le financement des infrastructures, l'exploitation et le monitoring du TDC.

RÉFÉRENCES

- MERZ C., SCHEUMANN R., EL HAMOURI B. AND KRAUMEM. (2007). Membrane bioreactor technology for the treatment of greywater from a sports and leisure club; *Desalination* 215, 37-43.
- EL HAMOURI B., J. NAZIH, AND J. LAHJOUJ (2007). Subsurface-horizontal flow constructed wetland for sewage treatment under Moroccan climate conditions *Desalination* 215, 153-158.
- EL HAFIANE F. and EL HAMOURI B. (2005). Anaerobic reactor/high rate pond combined technology for sewage treatment in the Mediterranean area. *Water Science & Technology* Vol 52, n°12 125-132.
- EL HAMOURI B. Réacteur Anaérobie et Chenal à Haut Rendement Pour l'épuration des eaux usées des petites communautés. Réalisation, exploitation et performances. Monographie. Institut Agronomique et Vétérinaire Hassan II. Novembre 2004.



DO LOCAL PEOPLE ACCEPT OUR GREYWATER TECHNOLOGY?

By Peter Laban*

This paper will challenge researchers and technicians with a number of questions that are important to get answers to, if research-tested technology has to find scale among local end-users in both rural and urban settings. Such questions relate to cultural acceptability, cost and benefits, knowledge needed to handle it, practicality. It is argued that in order to develop technology that can be used on scales where it really can impact sustainable water use, end-users or future clients need to be more involved in the problem analysis and design. Inspiration may be found for this in approaches developed in agricultural extension known as Participatory Technology Development.

* Peter Laban is Regional Coordinator in the EMPOWERS Partnership, laban@carewb.org

This workshop will take stock of new insights and achievements in the search for low-cost and acceptable technologies to treat and re-use waste water. It will also focus on the social and cultural acceptability of the use of grey water in the Middle East. Research into these issues is urgent as many people in this region suffer from important water scarcities and food insecurity. Technological contributions to solutions that respond to the demand for water at the household level are therefore a necessity. Such contributions will complement the search for more effective and participatory planning and policies in the water sector.

However, to be adopted by local people technology needs to be embedded in their cultural and socio-economic reality. This applies to both rural and urban settings. It is great to be able to demonstrate that one or another technology succeeds to treat waste water – grey or even black – in a way that is technically feasible and respects different ecological and quality/health criteria. However, if such a technology is financially not affordable and does not consider the cultural or even religious values that people adhere to, then it will become very difficult to apply such a technology on scales that have the desired impact. Moreover, many technologies introduced from outside suffer from the fact that people have not really taken ownership of the development of such a technology and thus often do not see its relevance in their daily lives.

There may be four important questions that people will raise when exposed to a new technology for the treatment and re-use of grey water.

1. **Am I allowed to use it?**
How acceptable is the technology in view of cultural and religious values?
2. **Can I pay for it and/or does it reduce my cost of living?**
How affordable is the technology and what are the financial benefits?
3. **How difficult is it to use?**
What is the required knowledge to install, operate and maintain it?
4. **Does it give me more water that I can use in a safe way?**
How does it improve access and rights to sufficient and good quality water?

In the following I would like to reflect with you on these questions which I think are critical to make sure that people will feel comfortable with such a new technology and will take ownership of its use and maintenance. Related to this I would also like to share with you insights in other domains that have demonstrated that methodologies that develop “new” technology in a participatory way have a better chance to respond positively to the questions above.

AM I ALLOWED TO USE IT?

“Maybe what you, a technician, say is valid, but how can we make use of it. In our culture it is not even allowed to put a bucket of water used for cleaning the floor of the house on the kitchen table!”



Fig. 1:
**CLEANING
OF THE FIRST
BARREL**

Indeed, how acceptable is the technology in view of cultural and religious values? In the Middle East there are strong taboos based or not on the holy scripts that make people very hesitant to re-use water that has been used for other purposes and is not anymore clean. In actual jargon such water when it originates from normal household use (kitchen, shower, sinks) is called "grey water". When it comes from the toilets it is called "black water". There seems to be some acceptance to use "grey water" for vegetables and fruit trees, however this acceptance is still not without hesitation. The use of "black water" is considered completely unclean. These taboos are strong and need to be faced in an open way. Experiments, water tests may help, but it will be a long process of awareness raising, education and dialogue that may have to start at primary schools. In any case the other questions below need to be answered in a satisfactory way first, before starting this dialogue. Maybe it is interesting to note that in Singapore the use of bottled water that is produced from treated "grey water" is now very widely accepted. In India, in the area around Bombay, farmers hijack trucks that transport "black water and waste". They use it to fertilize their crops, as the soil get poorer and poorer and does not produce sufficient food any more.

CAN I PAY FOR IT AND/OR DOES IT REDUCE MY COST OF LIVING?

"Well this looks very impressive and I am sure it works at your research station, but if I have to buy it, it certainly will be too expensive. And when using it, I am not very convinced that my daily cost for water will be less!"

Good questions! As development workers, researchers or technicians we often cannot give a satisfactory response to them. It is essential that technology is low-cost and can be easily installed also in the poorer house-

holds if the technology in question is intended to get to scale. It is not only the buying of the necessary equipment or materials and their price. As important is the possibility to get spare parts at the local market. Are they readily available? Can repairs be easily made at low cost? Too often these aspects are ignored in our R&D. It is not that certain that waste water treatment and re-use technology developed for larger institutions (offices, schools, university departments) can be applied easily in smaller units (isolated houses in the rural areas, individual apartments in bigger buildings). It is important to get out of the conventional R&D Box and focus on use in small units in order to get to the desired scale of impact. Further developing such technology together with the women and/or farmers who are supposed to use it is often essential to find out what are the bottlenecks and hesitations; and also to explore how such a technology can help people in finding solutions for problems they are facing directly themselves.

HOW DIFFICULT IS IT TO USE?

"Jamah, maybe this is good for you in your own house, but I am not at all sure that I can handle this, that it does not take too much of my time, that it does not make my household or farm work more heavy."

In general, people are reluctant to introduce new things when it is not crystal clear that it helps, saves time and is easy to use. In many cases people will observe how others are dealing with it before they make their decision. In Dutch we call this "looking the cat out of the tree". This question and the one above are closely connected. A positive answer to one question is not enough. Indeed equipment and technology should be cheap, easy to use, without much extra effort. In many cases people may say that after all, it is less difficult to continue the practices they are accustomed to. Just proposing such a ready-made technology, even if it is tested for those practical issues, often does not work. People are more ready to accept it when they have been involved in finding answers to their own problems and

Fig. 2:
TRAINING OF WOMEN





Fig. 3:

COMPLETE SYSTEM

difficulties, when they have participated in the search for technical and maintenance solutions and in the final design of the technology. If that has happened people probably feel more comfortable and will be more ready to accept it.

DOES IT GIVE ME MORE WATER THAT I CAN USE IN A SAFE WAY?

“Yes, it looks interesting, but if I have installed this thing will it save me water and is it really true that the water is more healthy and that my children will be less sick?”

People are reluctant when they do not see the benefit of getting cheaper, more and safer water with less effort. The extra benefits of an innovation have often to be much more than the difference in (extra) cost as compared with their current system (?Y/? X2). This is a general rule of thumb, reflecting the risks (cost and other risks) people implicitly calculate before making decisions. And they are right. How often has it happened that the nice equipment did not function properly, did not deliver what had been promised or had to be simply put in the garbage bin. Getting to scale and disseminating equipment through the market will almost always require the involvement of private enterprise. But often, private enterprise that sees a hole in the market will “sell” such new equipment very convincingly without sufficient quality control. Government services have a regulatory role and responsibility here. Take for instance the example of water filters that were widely distributed in Jordan, while it emerged later that most of the important micro-elements were also filtered out, causing health problems. Again involving customers in the design of the technology is often very useful.

PARTICIPATORY TECHNOLOGY DEVELOPMENT

From the above it is suggested that involving end-users or clients better in the analysis of difficulties they

face and in the design of a new technology will pay off. Of course this does not mean that the whole population of a country or area has to participate. A representative selection of households will do. If the technology is successful, meaning also that it responds positively to the above four questions, it will spread by itself and in a short time commerce will take over for further distribution. A lot of thinking has been done already in agriculture on how to involve farmers (men and women) better in the innovation of their farming practices. It has become known as Participatory Technology Development (PTD). In short it can be described as follows.

Participatory Technology Development is a participatory research and development approach developed on the premise that effective local technological innovation requires bringing together on an equal basis the knowledge and experiences of end-users/clients (farmers, women in households) with those from research and extension agencies. PTD, developed at the end of the 1980-ies by a wide group of NGOs and other development practitioners, is a systematically facilitated and community led-process, a series of activities, in which local constraints (e.g. to agricultural development, water management or use of domestic water) are identified, and analyzed. Subsequently, together with support agencies and research, potentially appropriate technical innovations are selected with these end-users, after which they go through a process of piloting, studying, experimenting, monitoring and evaluating these innovations to arrive at well founded solutions/technologies that can be used for further dissemination. PTD forms part of the conceptual and methodological thinking that developed since the end of the eighties on how to respect better the farmers' knowledge and come to more sustainable agriculture while reducing external inputs: Low External Input and Sustainable Agriculture (LEISA) [1]. It is evident that in such PTD processes ample consideration is given to the four questions mentioned above. Part of the technology development process has to take into account these concerns. They will surface logically as



Fig. 4:

NEW FODDER VARIETIES ARE INTRODUCED TO COMMUNITIES



Fig. 5:

TESTING OF THE WATER QUALITY

long as the future clients are involved from the start. Six different steps can be recognized in the PTD process (see Box below):

THE SIX STEPS OF PTD

1. Getting started in specific communities
2. Understanding problems and opportunities; priority setting
3. Looking for potential solutions to try-out
4. Experimenting (participatory farmer research)
5. Sharing the results = end-user based extension
6. Sustaining the innovation process (people taking research initiatives themselves)

A Trainer Guide for PTD facilitators [2] was tested and subsequently published by ETC in 1997 and translated into other languages (French, Portuguese, Bahasa Indonesia, Chinese, ...). It was translated into Arabic by CEOSS in Egypt, where it has been used since 1996 [3].

ACKNOWLEDGMENT

This paper was presented at the Aqaba Greywater Stock-Taking meeting, held from 11 to 15 February 2007 under the auspices of the International Development Research Centre (IDRC), Canada, in conjunction with the Center for the Study of the Built Environment (CSBE), Jordan and will also be published in the proceedings of this seminar.

REFERENCES

- [1] Reijntjes, C., B. Haverkort and A. Waters-Bayer (1992). Farming for the future; An introduction to Low-External-Input and Sustainable Agriculture. ETC/ILEIA, Leusden and MacMillan Education Ltd., London.
- [2] Veldhuizen L. van, A. Waters-Bayer and H. De Zeeuw (1997). Developing technology with farmers: a trainer's guide for participatory learning (London, ZED Books) (also available in Arabic; Cairo, CEOSS)
- [3] Zakaria G. and P. Laban (1997). Recycling household waste to improve soil fertility. ILEIA Newsletter 13

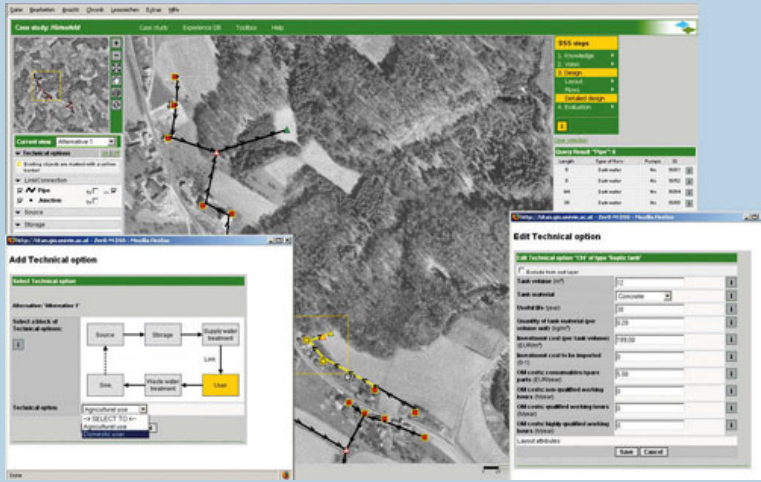

DECISION SUPPORT SYSTEM FOR SUSTAINABLE WATER MANAGEMENT

By ALEXANDER PUCHER, SIBYLLE SAUL and KAREL KRIZ*

The Zer0-M project has developed a Decision Support System (DSS) in order to contribute to the dissemination of the Sustainable Water Management (SWM) approach. The aim is to provide experts and technicians with a tool that helps them to develop and compare multiple SWM solutions for an existing problem. Thus, it is helping them to choose the optimum solution according to clearly defined criteria.

* Alexander Pucher, Sibylle Saul and Karel Kriz
University of Vienna, Department of Geography and Regional
Research, Universitätsstraße 7, 1010 Vienna, AUSTRIA
alexander.pucher@univie.ac.at, sibylle.saul@univie.ac.at,
karel.kriz@univie.ac.at

Given the vast amount of possible Sustainable Water Management (SWM) technologies available, the task of choosing 'the right one' for a given problem is a big challenge. In addition to higher efforts, a lot of information is needed in order to be able to develop and compare different SWM solutions. The information needed includes knowledge about the situation and problems to be addressed. It also requires background knowledge about the technologies available as well as their specific characteristics and requirements. The lack of this information and the multiplication of the workload often prevent the responsible experts from comparing a great many different possible solutions. Thus, they are less likely to consider technologies they are not acquainted with which might offer better solutions to their problem. In order to alleviate the workload necessary for the development and comparison of multiple SWM solutions, a Decision Support System (DSS) has been developed within the scope of the Zer0-M project.

OBJECTIVES

The general term Decision Support System (DSS) describes a (computer) tool that supports people when making decisions, in a broader sense. The target of the DSS developed is to provide experts and technicians with a tool that helps them to develop and compare multiple SWM solutions for an existing problem. As the word 'design' in its name already implies, the DSS is mainly intended to help design sustainable water supply and disposal systems from a broad technical perspective. This means that the design of SWM solutions is done in a rough way. In order to be able to decide on a solution for existing localities and their major problems regarding water management, the DSS helps the user to consider and evaluate a range of different SWM technologies. The DSS will guide the user to consider different SWM options, integrate them in a design and/or planning activity and provide a logical procedure to compare project alternatives. This involves decision makers (representatives, population, traditional authorities, and water departments) in order to identify the most suitable solution and to show its relevant (economic, environmental, socio-cultural) impacts in a sustainability framework. Feasible solutions are developed by considering these technologies and combinations of them. The pro and contra of each solution is then assessed by means of clearly specified criteria. Thus, the evaluation of the system helps to find the (possibly) best answer to the problems addressed.

The DSS is mainly intended to help design sustainable water supply and disposal systems from a broad technical perspective, roughly at a scale of about 1:25.000. Focused areas are small settlements in rural areas, isolated tourism facilities or peri-urban areas not connected to a centralized waste water collection and treatment system. This means the size of the case studies corresponds to the following:

- a single house
- scattered houses

- a compact settlement of houses (e.g. isolated geographically, by socio-economic or artificial boundaries for design purposes)

The users of the DSS will mainly be technical planners/designers of water and waste water systems (e.g. sanitary engineer or a team comprising the expertise of engineers, agronomists, socio-economists, environmental planners, biologists, etc.). Decision makers will contribute to the design providing the designer(s) with basic information concerning the decision. This is done by representing or directly involving their community. Basic information concerning the decision may be a judgment on the importance of criteria for decision making or cultural constraints, etc.

IMPLEMENTATION

One of the main objectives of the development of this tool was to guarantee as easy an approach as possible for the user. This was realized by focussing on two important implementation aspects. The DSS was realized as an internet-based application. This enables worldwide access to the system over the internet and thereby stimulates the cooperation between multiple partners by providing a centralized system, instead of multiple individual versions. Regarding the software used, the developer team concentrated strictly on using Open Source software components. Besides the fact that through this the Zer0-M DSS is available without software vendor costs or licences, it offers the possibility to adapt the programming code to the special needs of the Zer0-M project objectives [4].

DECISION MAKING PROCESS

A schematic representation of the water system is used as a framework for the development and implementation of all models embedded in the DSS [Fig.1]. This schematization is also reflected in the DSS utilities. The water system is divided into 7 blocks representing categories of elements that have to be specified for a proper description of the system for simulation purposes [1]. The scheme serves as a reference for the layout of a real physical system, which might result in much more complex and articulate structures compared to this simple schematic representation. Real systems might have many different users, various sources and multiple connections between all elements. Therefore, not all blocks need necessarily to be part of a specific layout, or to be connected. Furthermore, the same type of element can be used as often as needed. Most of them are additive which means that elements of the same block may be introduced as serially connected ones. However, the schematization represents a logical path that the user has to consider while defining the scheme of an individual system. It has to be stressed that sustainability is reached through the selection of sustainable technologies for water collection, water saving and waste water treatment as well as through a proper layout of the system, e.g. connecting elements

in such a way that the reuse of water and nutrients can be performed.

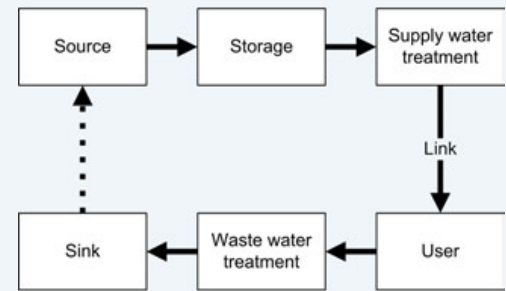

Fig. 1:

SCHEMATIC REPRESENTATION OF THE WATER SYSTEM USED IN THE DECISION SUPPORT SYSTEM

Each category comprises several elements, among which the user can choose when implementing a given “block” of the layout. These elements are called Technical options (TOs). During the layout composition, the DSS is checking the compatibility of the connections set up by the DSS user.

Planning and management are based on a problem solving process which begins with the problem definition and description, involves various forms of analysis, and then leads to design, usually followed by the evaluation of alternative solutions. The DSS guides the user through the whole decision process that includes the following steps [2]:

- Knowledge: data acquisition and characterization of the situation and problem
- Vision: preliminary identification of suitable type(s) of water system to be adopted
- Design: for each alternative, the design stage is split into 3 sub-steps:
 - Layout: definition of all the elements of the given alternative, including all the information needed to run the water system model
 - Flows: simulation of water and mass flows (this is indeed part of the evaluation capability but it is carried out here since usually for detailed design the knowledge of water flows is needed)
 - Detailed design: selection and specification of all technical characteristics of each element of the water system
- Evaluation: prediction of the performance of all of the alternatives (i.e.: calculation of all the evaluation indicators for each alternative)
- Choice: multicriteria analysis of alternatives (evaluation and ranking, plus sensitivity analysis). At this stage this last step is not included in the DSS tool and has to be carried out by exporting the results of the evaluation to a separate multicriteria analysis module (a simple MS Excel file may be suitable).

In the beginning, the existing problems have to be identified and specified. Tools for visual and exploratory data analysis are provided and help the user to achieve a more holistic view of the situation and possible solutions. However, thematic and geographic information has to be acquired beforehand in order to be evaluated by the user. Geographic information—including thematic and geometric information—is needed for



Fig. 2: THE GPS-BASED DATA ACQUISITION TOOL ADAPTED TO THE NEEDS OF THE DSS; THE COLLECTION OF INFORMATION REQUIRED FOR THE DESIGN AND COMPARISON OF POSSIBLE SOLUTIONS IS ENSURED.

the general description and analysis of the situation. It is also needed for the development of possible solutions and their evaluation through the calculation of indicators. For the simplification of the data acquisition process, a GPS-based data acquisition tool supplying the DSS and its user with all the information required has also been developed during the Zer0-M project [Fig. 2a+b]. This tool helps the user to collect all the information desired or required in the specified format needed by the DSS already in the field. Through a clearly defined interface, the data can then be easily imported into the DSS, making it readily available.

Having all the data available, the definition of the existing situation and major problems is used for a screening of similar experiences maintained in an 'Experience Database'. In general, the 'Experience Database' represents a forum for the exchange of existing experiences. Standardised information describing the situation and problems as well as the layout of the solution is retrievable. A document repository for each experience gives the possibility to distribute further information to a wider audience.

During the development of alternatives, the 'Experience Database' gives the user the ability to search for experiences facing similar circumstances and problems. By screening the solutions implemented, the user retrieves information about suitable and non-suitable technologies. Additionally, the user is encouraged to consider different technologies and combinations of technologies by the possibility to retrieve more detailed information on SWM technologies. These experiences are used for the development of a vision and to obtain a first idea about suitable technologies.

Based on all of this information, the user then develops possible solutions to the problems identified in the beginning. Alternatives are being designed using functionalities of a Geographic Information System (GIS)—supporting the development of the layout—and attribute information describing all of these elements [3]. Finally, the SWM solutions developed have to be evaluated in order to be able to choose the optimum. The comparison is done on a multicriteria approach based on the results of simulations.

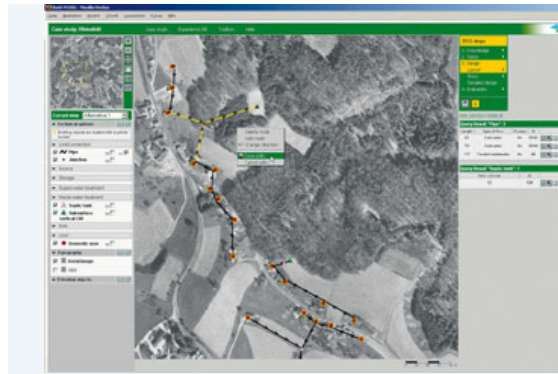

Fig. 3: CENTRAL POINT OF THE DSS IS THE INTERACTIVE MAP VISUALISING AND MAKING ACCESSIBLE ALL THE INFORMATION AVAILABLE.

DESIGN OF ALTERNATIVES

The design phase involves the development of spatially and thematically defined alternatives as possible solutions for problems that were identified at the beginning of the analysis. The central point for their development in the DSS is the interactive map [Fig. 3]. Through this interactive map the user is able to explore and access all the information available. The design of alternatives is done by positioning and connecting technical objects. This can be done by directly adding and editing objects on the map. In the background, system based functions check the general consistency and admissibility of connections.

For a complete description, attribute information has to be given for each object positioned on the map, such as "How many people use this facility? How large is the impermeable surface? How much does this material cost?". Where possible, the system provides some default values that can be used by the user. However, there is always the possibility to directly introduce values describing the local situation more correctly.

EVALUATION

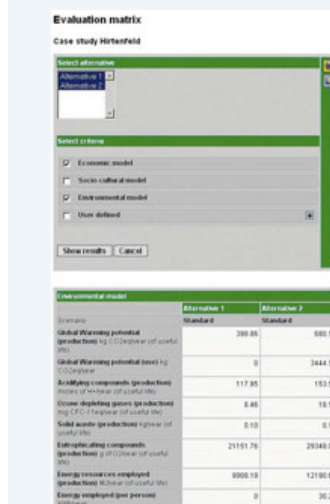

Fig. 4: EXAMPLE OF THE EVALUATION MATRIX, SHOWING THE RESULTS OF THE ENVIRONMENTAL MODEL FOR TWO DIFFERENT ALTERNATIVES

The comparison of SWM solutions in the DSS is done in a multicriteria approach. The results of simulations are indicators representing the performance of the relevant alternatives [Fig.4]. Their impacts are assessed mainly in relation to their sustainability from an economic, social and environmental point of view.

Indicators calculated for SWM solutions designed include (see Fig. 5):

- **Environmental criteria:**
- **“Zero-M-ity”:** This criterion expresses the results of alternatives regarding the maximization of water reuse and the minimization of emissions. Included are indicators depicting the total water flow extracted per person, degree of reuse and recycling of water, degree of nutrients reuse, energy employed per person.
- **Local environmental impact:** Qualitative and quantitative indicators are calculated for the assessment of local environmental impact. This includes the calculation of abstraction and quality pressure on sinks as well as the influence on the ecosystem and landscape.
- **Non-local environmental impact:** Life cycle analysis takes into account the production process of materials. Thereby, indicators on the global warming potential, acidifying compounds, ozone depleting gases, solid waste, eutrophication compounds, and energy resources employed are calculated.
- **Economic criteria:** Indicators relating to the economic criteria include the present discounted value, investment costs, import costs, operation and maintenance cost per year.
- **Socio-cultural criteria:**
- **Local Mastering:** Difficulties considering the mastering of an alternative depend on the technologies adopted and the information given by the local expert.
- **Socio-cultural acceptability:** Quantitative and qualitative indicators are calculated for the assessment of the acceptability of an alternative relating to the change in social/cultural habits and satisfaction of the user’s water demand.

CONCLUSION

With the development of the Decision Support System by the Zer0-M project a tool is made available,

which especially focuses on the use for Sustainable Water Management. By using Open Source Software, the DSS is developed in an extendable and flexible way to be specifically adapted to the original task. Thus, it is giving the user the possibility to design and evaluate SWM alternatives in a powerful but easy way and helps to propagate the ideas and implementation of SWM.

ACKNOWLEDGMENTS

As is the case with most consortia research projects, several persons contributed greatly to the work presented in this paper. On behalf of the University of Vienna, responsible for the technical implementation, we would like especially to point out the contribution of ALT (Ambiente e Lavoro Toscana–O.N.L.U.S.) to the theoretical framework.

Zer0-M is a project of the Euro-Mediterranean Regional Programme For Local Water Management under the Euro-Mediterranean Partnership.

REFERENCES

[1] Goltara, A., Nardini, A., Conte, G. und F. Masi (2004) Schematization of the Water System. Zer0-M Project Document ZM-WP4-TD-DSS-Network5-3.doc

[2] Nardini, A., Goltara, A. und I. Principi (2005) DSS Modelling. Zer0-M Project Document ZM-WP4-TD-DSS5-8.doc

[3] Niederer, S., Pucher, A. und K. Kriz (2004): Angepasste Kartographie und Geoinformatik als Werkzeuge für eine nachhaltige Wasserwirtschaft im Euro-Mediterranen Raum. In: Strobl, Blaschke, Griesebner: Angewandte Geoinformatik 2004. Beiträge zum 16. AGIT-Symposium Salzburg, S. 500 - 505.

[4] Pucher, A. (2003) Open Source Cartography: Status Quo, Recent Trends and Limitations of Free Cartographic Software. In: Proceeding of the 21st International Cartographic Conference (ICC), International Cartographic Association (ICA), Durban, pp. 1835 - 1844.

Fig. 5: OVERVIEW OF INDICATORS, IMPLEMENTED IN THE EVALUATION PROCESS OF THE ZERO-M DECISION SUPPORT SYSTEM

	“Zero-M-ity”	Local environmental impact	Non-local environmental impact	
Environmental	Total water flow extracted per person	Abstraction pressure on sources	Global Warming potential	Eutrophication compounds
	Degree of reuse and recycling of water	Quality-pressure on sinks (N, P, COD, Salinity)	Acidifying compounds	Energy resources employed
	Degree of Nutrients reuse (N, P)	Ecosystems (worsened or improved)	Ozone depleting gases	
	Energy employed (per person)	Landscape quality (worsened or improved)	Solid waste	
Economic	Present (discounted) value of total costs	Investment costs	Import costs	Operation and maintenance (O&M) costs per year
Socio-cultural	Local Mastering of technologies adopted	Socio-cultural acceptability of solution adopted	Satisfaction of users water demand	Nuisance (mosquitoes, smell)

NOR ANY DROP TO DRINK

“Nor Any Drop to Drink” is a film made by Sapiens Productions in collaboration and with support of the International Water and Sanitation Centre (IRC) and the Empowers and Zer0-M projects. Four filmmakers from Jordan, Egypt and Palestine find out how local people and institutions on the ground work together in solving the water scarcity.

In this Earth Report, we see how countries in the Middle East are beginning to confront the stark reality of too many people and too little water. We first travel to Jordan, a country that is experiencing a severe and worsening water shortage. Damiya village suffers from an inadequate and poorly-maintained water system, problems which are tackled through dialogue between officials and users. In the farming area of Beni Suef in Egypt, demand for irrigation water is high and farmers are desperate. Here too water users have started to discuss the problems with government officials to come up with solutions. But these dialogues can only work if practical solutions are the outcome. Innovative ideas at local level often provide solutions for local water shortages – in Maithaloun in Palestine, Mustafa has developed an innovative water harvesting project. He manages to turn his idea into a viable municipality project.

NOR ANY DROP TO DRINK is distributed by the Television Trust for the Environment (TVE). It can be ordered through TVE's homepage at <http://www.tve.org/mp7/details.cfm?l=e&fid=3114>



Nor Any Drop To Drink

Directors:
DANA TABARI (Jordan)
ABDALLAH KHALIFA (Jordan)
MOUSTAFA YOUSSEF (Egypt)
OMAR NAZZAL (Palestine)

Production manager:
TON SCHOUTEN

Producer:
JOSHKA WESSELS

A film produced by Sapiens Productions
for the Television Trust for the Environment (TVE)
with support of
The EMPOWERS Partnership
CARE International
EC-MEDA Water Programme
IRC International Water and Sanitation Centre
The Zer0-M Project

© 2007 Television trust for the Environment

INTERNATIONAL EVENTS

Start	End	Event (Type)	Country/ Town	Organisation	Link
2007-09-03	2007-09-06	3 rd International Conference on Climate and Water (Conference)	Finland/ Helsinki	Organised by the Finnish Environmental Institute SYKE	http://www.environment.fi/syke/cw3
2007-10-09	2007-10-12	6 th International IWA Specialist Conference on Wastewater Reclamation and Reuse for Sustainability (WRRS 2007 - Conference)	Belgium/ Antwerpen	Organised by IWA (www.wrrs2007.org)	http://www.wrrs2007.org/en/?n=2
2007-10-24	2007-10-26	EnviroMaroc 2007 (Conference)	Morocco Casablanca	Ministry of Regional Development, Water and Environment	http://www.gtz.de/en/weltweit/maghreb-naher-osten/marokko/6433.htm
2007-10-24	2007-10-27	Aquaculture Europe 2007 (Conference)	Turkey/ Istanbul	European Aquaculture Society	http://easonline.org/
2007-11-11	2007-11-15	Wastewater Treatment in Small Communities (Conference)	Spain/ Sevill	CENTA	http://www.smallwat.org/
2008-06-14	2008-09-14	International exposition Saragoza 2008 "Water and Sustainable Development" (Exposition)	Spain/ Zaragoza	Bureau International des Expositions, B.I.E	www.expozaragoza2008.es



ZERO-M

MEDA Water



SUSTAINABLE CONCEPTS TOWARDS A ZERO OUTFLOW MUNICIPALITY

CONTRACTING AUTHORITY

EUROPEAN COMMISSION / Delegation of the European Commission in Jordan

PROGRAMME

EURO-MEDITERRANEAN PARTNERSHIP

Euro-Mediterranean Regional Programme For Local Water Management

BUDGET LINE B7- 4100

APPLICANT:



AEE INTEC

AEE – Institute for Sustainable Technologies

Feldgasse 19, 8200 Gleisdorf, Austria

Martin Regelsberger, tel: 03112 5886 –50, m.regelsberger@aee.at

Barbara Regelsberger, tel: 03112 5886-50, b.regelsberger@aee.at

PARTNERS:



ALT

Associazione Ambiente e Lavoro Toscana –

O.N.L.U.S.,

Via Pier Capponi 7, 50132 Firenze, Italy



MRC

Tübitak-Marmara Research Center,

Gebze, Kocaeli, Turkey



NRC

Water Research & Pollution Control Department,

National Research Centre,

Tahreer street, Dokki, Cairo, Egypt



**CERTE
(LTREU)**

Centre de Recherche et des Technologies des Eaux

Laboratoire Traitement et Recyclage des Eaux Usées

BP. 273, 2050 Hammam Lif, Tunisia



**IAV
(WTRU)**

Institut Agronomique et Vétérinaire Hassan II,

Wastewater Treatment and Reuse Unit,

Madinat Al Irfane, Rabat, Morocco



**IGR
(Univie)**

Department of Geography and Regional Research,

University of Vienna,

Universitätsstr. 7, 1010 Vienna, Austria



**TUB-
kubus
+ TUB-
VT**

Technische Universität Berlin,

Zentraleinrichtung Kooperation and

Institut für Verfahrenstechnik,

Franklinstr. 28/29, 10587 Berlin, Germany



wB

Universität Hannover, Zentrale Einrichtung

für Weiterbildung (weiterBILDUNG),

Schlosswenderstr. 5, 30159 Hannover, Germany



fbr

Fachvereinigung Betriebs- und Regenwasser-

nutzung e.V.

Havelstr. 7a, 64295 Darmstadt, Germany

Fabio Masi,
tel: 0039 055 470 729,
masi@altnet.it

Ahmet Baban,
tel: 0090 262 677 2904,
Ahmet.Baban@mam.gov.tr

Hussein Abdel Shafy,
tel: 0020 2 376 25 349,
hshafywater@yahoo.com

Ahmed Ghrabi,
tel: 00216 71 410 740,
ahmed.ghrabi@certe.nrnt.tn

Bouchaib el Hamouri,
tel: 00212 37 77 75 64,
b.elhamouri@iav.ac.ma
elhamouri@menara.ma

Karel Kriz,
tel: 0043 01 4277 48641,
kriz@atlas.gis.univie.ac.at

Gisela Prystav
(geb. Hoffmann),
tel: 0049 30 314 24617,
gisela.prystav@zek.tu-berlin.de

Martin Beyersdorf,
tel: 0049 511 762 4745
Erika Villa
tel: 0049 511 965 99 707,
villa@targetgmbh.de

Dietmar Sperfeld,
tel: 0049 6151 33 92 57,
info@fbr.de